



Connect with the Best

# PCB

CONNECTORS  
CATALOGUE

基板用コネクタカタログ



# PCB 接続技術一覧

PCB mounting technology

接続技術 Mounting technology	スルーホール (TH) Through-hole (TH)	プレスフィット (PF) Press-fitting (PF)	表面実装 (SMT) Surface mounting technology (SMT)	スルーホールリフロー (THR) Through-hole reflow (THR)
外観 Appearance				
実装エリア制約 Area restriction of mounting	○ (TH 必要) Needs TH	○ (TH 必要) Needs TH	◎ (両面実装可能) Enables bothside-mounting	○ (TH 必要) Needs TH
実装工程簡素化 Simplification of mounting	○ (局所フロー必要) Needs reflow on selective area	○ (専用圧入設備必要) Needs a special press-fitting Machinery	◎	◎
多極対応 Multi-pole application	◎	◎	○	◎
使用環境対応 Use environment	◎	◎	○	◎

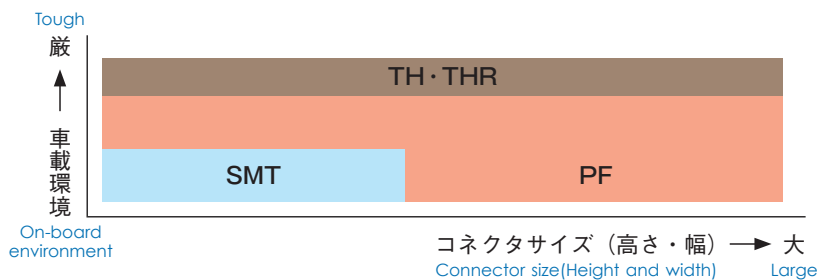

※弊社では基板接続を含めた様々な基礎技術を保有しています。  
\*SWS possesses a variety of basic technology including PCB mounting.

# 様々な基礎技術に基づいた応用製品紹介

Introduction of application products based on a variety of basic technology

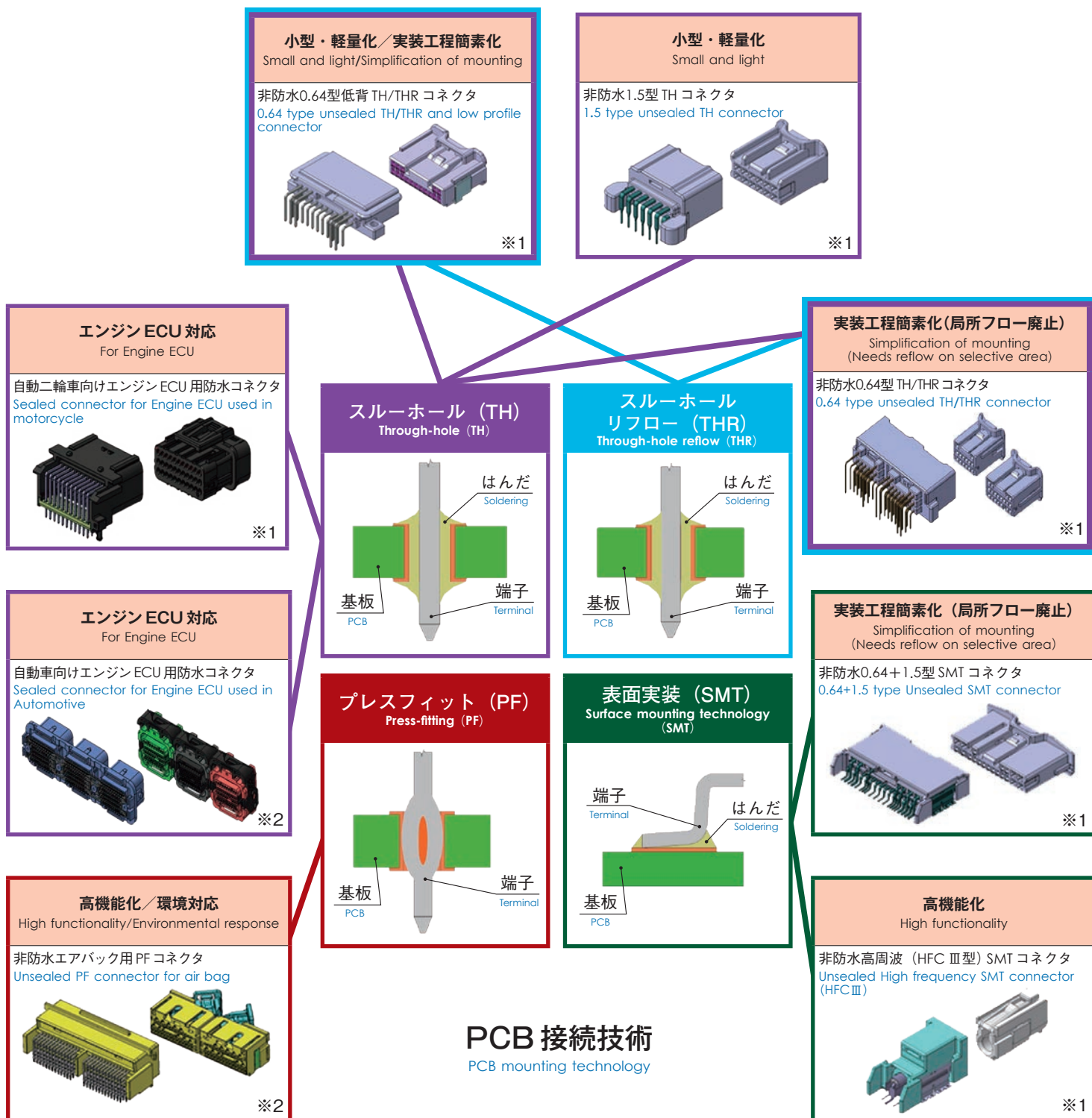

## ご連絡

※1：汎用カタログ品 ※2：ユニット専用品

新規開発及び汎用品の仕様違いのご要望がありましたら、弊社営業までご相談下さい。

## Information

\*1: General purpose product \*2: Dedicated products for units

Please contact us for request of new development and different specifications of general purpose products.

# 【参考】コネクタ種類の定義（電気的分類）

[Reference] Definition of the connector types (Classified by electric features)

## ISO(8092) によるタブサイズの定義

Definition of the tab size in accordance with ISO (8092)

### オスタブ幅にて端子サイズを分類

The terminal size is classified by male tab width.

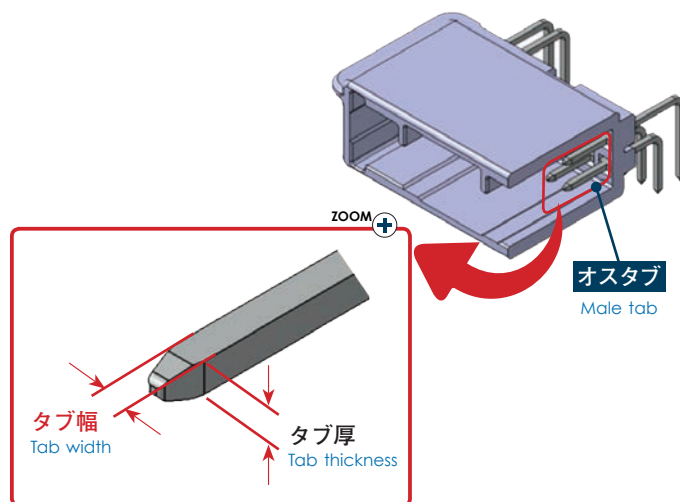

コネクタ種類 Connector type	タブ幅 (inch) Tab width	タブ幅 (mm) Tab width	タブ厚 (mm) Tab thickness	タブ長さ (mm) Tab length	住友コネクタ仕様 Sumitomo connector specification		
					適用電線サイズ (mm <sup>2</sup> ) Applicable wire size (mm <sup>2</sup> )	電流容量 (参考値) Applicable current (Reference value)	電圧 Voltage
0.64型 type	025	0.64	0.64	5.5以上 Min.	0.13~0.5	(7A)	14V
1.0型 type	040	1.0	0.64	6.2以上 Min.	0.13~0.5	(10A)	
1.5型 type	060	1.5	0.64/0.8	7.4以上 Min.	0.13~2	(20A)	
1.8型 type	070	1.8	0.64	6.7以上 Min.	—	(—)	
2.3型 type	090	2.3	0.64	6.7以上 Min.	0.13~2	(20A)	
2.8型 type	110	2.8	0.8	8.1以上 Min.	0.3~2	(24A)	
4.8型 type	187	4.8	0.8	8.0以上 Min.	0.3~3	(33A)	
6.3型 type	250	6.3	0.8	10.1以上 Min.	0.5~3	(30A)	
7.7型 type	305	7.7	0.8	9.8以上 Min.	2~8	(50A)	
8.0型 type	312	8.0	0.8	8.9以上 Min.	3~8	(55A)	
9.5型 type	375	9.0	1.2	14.5以上 Min.	3~10	(80A)	

# 製品インデックス





Product index



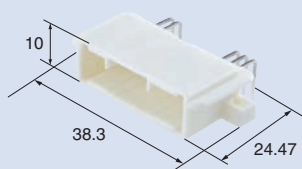

## 自動車用 Automotive USE

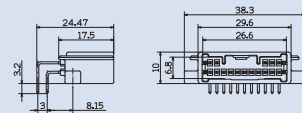
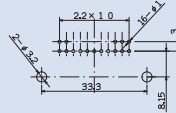

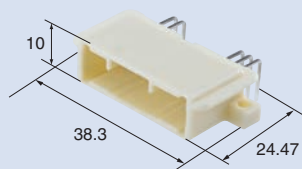

No.	防水性能 Sealing performance	シリーズ Series	コネクタ種類 Connector type	極数 No. of poles	嵌合方向 Mating direction	ハウジング材質 Housing material	基板接続 PCB mounting	梱包仕様 Packing Spec. (※ See P15)	PCBコネクタ品番 PCB connector part No.	メスコネクタ品番① メスコネクタ品番② メスコネクタ品番③ Female connector part No.			掲載頁 Reference page
1	非防水 Un-sealed	TS	0.64	16	水平 Horizontal	PBT	TH	スティック Stick	6098-6790	6098-4008			5
2	非防水 Un-sealed	TS	0.64	16	水平 Horizontal	SPS	TH/THR	スティック Stick	6098-6793	6098-4008			
3	非防水 Un-sealed	TS	0.64	33 (19+14)	水平 Horizontal	SPS	TH/THR	トレイ Tray	6098-7229	6098-7241	6098-7231		
4	非防水 Un-sealed	TS	0.64	36	水平 Horizontal	PBT	TH	スティック Stick	6098-6796	6098-4740			
5	非防水 Un-sealed	TS	0.64	36	水平 Horizontal	SPS	TH/THR	スティック Stick	6098-6798	6098-4740			6
6	非防水 Un-sealed	TS	0.64	56 (24+16+16)	水平 Horizontal	SPS	TH/THR	スティック Stick	6098-6848	6098-6682	6098-6688	6098-6694	
7	非防水 Un-sealed	TS	0.64	60 (36+24)	水平 Horizontal	SPS	TH/THR	スティック Stick	6098-6803	6098-4010	6098-4740		
8	非防水 Un-sealed	TS	0.64	68 (40+28)	水平 Horizontal	PBT	TH	スティック Stick	6098-6810	6098-4756	6098-4015		
9	非防水 Un-sealed	TS	0.64	68 (40+28)	水平 Horizontal	PBT	TH	スティック Stick	6098-6805	6098-4756	6098-4831		7
10	非防水 Un-sealed	TS	0.64	68 (40+28)	水平 Horizontal	SPS	TH/THR	スティック Stick	6098-7102	6098-4756	6098-4831		
11	非防水 Un-sealed	TS	1.0	4	垂直 Vertical	PBT	TH	スティック Stick	6098-2214	6098-2163			
12	非防水 Un-sealed	TS	1.0	10	垂直 Vertical	PBT	TH	スティック Stick	6098-2257	6098-3015			
13	非防水 Un-sealed	TS	1.0	10	水平 Horizontal	PBT	TH	スティック Stick トレイ Tray	6098-2434 6098-3353	6098-3015			8
14	非防水 Un-sealed	TS	1.0	18	垂直 Vertical	PBT	TH	スティック Stick トレイ Tray	6098-2165 6098-2444	6098-3019			
15	非防水 Un-sealed	DL	1.5	12	水平 Horizontal	SPS	TH	スティック Stick トレイ Tray	6098-6210 6098-6883	6098-5718			
16	非防水 Un-sealed	TS	4.8	3	水平 Horizontal	SPS	TH	スティック Stick	6098-5569 6098-5797	6098-5346			
17	非防水 Un-sealed	HE	4.8	5	水平 Horizontal	SPS	TH	トレイ Tray	6098-4688	6098-4667			9
18	防水 Sealed	HW	7.7	2	水平 Horizontal	PBT	TH	トレイ Tray	6188-4948	6189-7022			
19	防水 Sealed	DL	7.7	2	水平 Horizontal	PBT	TH	トレイ Tray	6188-4949	6189-7023			
20	非防水 Un-sealed	TS	8.0	2	水平 Horizontal	PBT	TH	スティック Stick	6098-2893	6098-1104			10
21	非防水 Un-sealed	TS	8.0	2	水平 Horizontal	PBT	TH	スティック Stick	6098-2895	6098-2897			
22	非防水 Un-sealed	HT	8.0	2	水平 Horizontal	SPS	TH	トレイ Tray	6098-7493	6098-2897			
23	非防水 Un-sealed	DL	0.64+1.5	10+8	水平 Horizontal	SPS	TH	スティック Stick トレイ Tray	6098-6212 6098-6885	6098-5611			
24	非防水 Un-sealed	TS	0.64+1.5	14+6	水平 Horizontal	LCP	SMT	トレイ Tray	6098-6869	6098-6876			11
25	非防水 Un-sealed	HE	1.0+2.3	19+4	垂直 Vertical	PBT	TH	トレイ Tray	6098-3572	6098-3571			
26	非防水 Un-sealed	HE	1.0+2.3+4.8	19+16+2	水平 Horizontal	PBT	TH	トレイ Tray	6098-6568	6098-4366	6098-4367		
27	非防水 Un-sealed	HFC	HFC III	1	水平 Horizontal	SPS	手はんだ付け Hand Soldering	トレイ Tray	6098-6157	6098-6321			
28	非防水 Un-sealed	HFC	HFC III	1	水平 Horizontal	SPS	手はんだ付け Hand Soldering	トレイ Tray	6098-6159	6098-6323			12
29	非防水 Un-sealed	HFC	HFC III	1	水平 Horizontal	LCP	SMT	エンボス Emboss	6098-7132	6098-6321			
30	非防水 Un-sealed	HFC	HFC III	1	水平 Horizontal	LCP	SMT	エンボス Emboss	6098-7134	6098-6323			
31	非防水 Un-sealed	HFC	HFC III	1	水平 Horizontal	LCP	SMT	エンボス Emboss	6098-7449	6098-7445			
32	非防水 Un-sealed	HFC	HFC III	1	水平 Horizontal	LCP	SMT	エンボス Emboss	6098-7450	6098-7446			13
33	非防水 Un-sealed	HFC	HFC III +0.64	2+1	水平 Horizontal	SPS	TH	スティック Stick	6098-5761	6098-6037			
34	非防水 Un-sealed	HFC	HFC III +0.64	4+2	水平 Horizontal	SPS	TH	トレイ Tray	6098-6700	6098-6702			

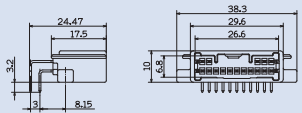
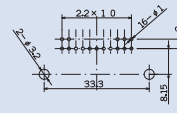

## 自動二輪車用 Motorcycle use

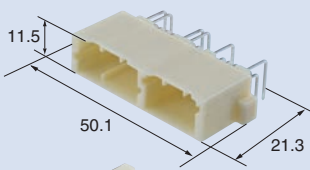

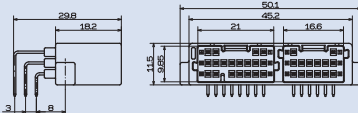
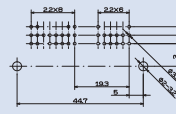

No.	防水性能 Sealing performance	シリーズ Series	コネクタサイズ Connector size	極数 No. of poles	嵌合方向 Mating direction	ハウジング材質 Housing material	基板接続 PCB mounting	梱包仕様 Packing Spec. (※ See P15)	PCBコネクタ品番 PCB connector part No.	メスコネクタ品番① メスコネクタ品番② メスコネクタ品番③ Female connector part No.			掲載頁 Reference page
35	防水 Sealed	—	0.64	33	水平 Horizontal	PBT	TH	スティック Stick	6188-4871	6189-7106			14
36	防水 Sealed	—	0.64	33	水平 Horizontal	PBT	TH	トレイ Tray	6188-0800	6189-7106			
37	防水 Sealed	—	0.64	21	水平 Horizontal	PBT	TH	トレイ Tray	6188-0790	6189-7108			

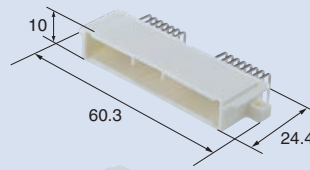
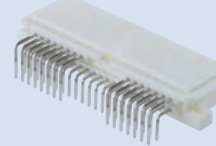
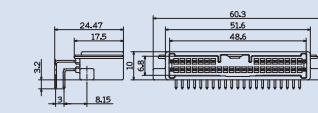
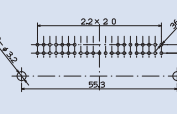

No.	端子サイズ Connector Size	極数 No. of Way Variation	シリーズ Series	防水性能 Sealing performance
1	0.64	16	TS	非防水 UnSealed
<p>Mコネクタ品番 (6098-6790) Connector M part No.</p>  <p>10 38.3 24.47</p>  <p>●参考寸法 Reference dimension</p>  <p>●基板推奨寸法 Recommended dimension of Circuit board</p>  <p>Fコネクタ品番 Connector F part No. (6098-4008)</p> 				
<p>用途 Use 自動車 Automobile</p> <p>嵌合方向 Mating direction 水平 Horizontal</p> <p>色相 Color 自然色 Natural</p> <p>ハウジング材質 Housing material PBT</p> <p>接点部めっき Plating on Contact Sn</p> <p>基板側めっき Plating on PCB side 4面Snめっき Sn plating on all sides</p> <p>基板接続 PCB mounting TH</p> <p>基板固定 Mounted Way ねじ Screw</p> <p>梱包仕様 Packing Spec. スティック Stick</p>				

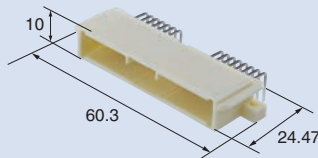
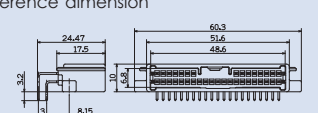
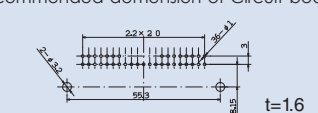

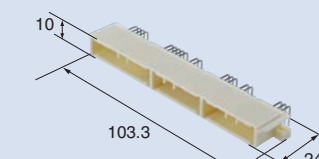
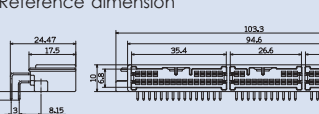
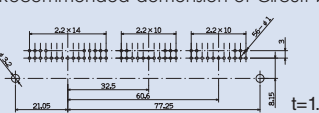
No.	端子サイズ Connector Size	極数 No. of Way Variation	シリーズ Series	防水性能 Sealing performance
2	0.64	16	TS	非防水 UnSealed
<p>Mコネクタ品番 (6098-6793) Connector M part No.</p>  <p>10 38.3 24.47</p>  <p>●参考寸法 Reference dimension</p>  <p>●基板推奨寸法 Recommended dimension of Circuit board</p>  <p>Fコネクタ品番 Connector F part No. (6098-4008)</p> 				
<p>用途 Use 自動車 Automobile</p> <p>嵌合方向 Mating direction 水平 Horizontal</p> <p>色相 Color 自然色 Natural</p> <p>ハウジング材質 Housing material SPS</p> <p>接点部めっき Plating on Contact Sn</p> <p>基板側めっき Plating on PCB side 4面Snめっき Sn plating on all sides</p> <p>基板接続 PCB mounting TH/THR</p> <p>基板固定 Mounted Way ねじ Screw</p> <p>梱包仕様 Packing Spec. スティック Stick</p>				

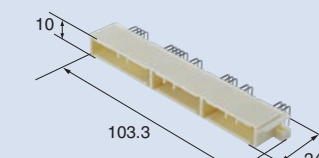
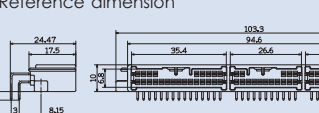
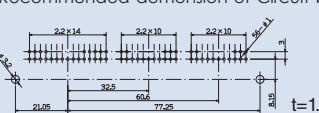

No.	端子サイズ Connector Size	極数 No. of Way Variation	シリーズ Series	防水性能 Sealing performance
3	0.64	33(19+14)	TS	非防水 UnSealed
<p>Mコネクタ品番 (6098-7229) Connector M part No.</p>  <p>11.5 50.1 21.3</p>  <p>●参考寸法 Reference dimension</p>  <p>●基板推奨寸法 Recommended dimension of Circuit board</p>  <p>Fコネクタ品番 Connector F part No. (6098-7241) (6098-7231)</p>  				
<p>用途 Use 自動車 Automobile</p> <p>嵌合方向 Mating direction 水平 Horizontal</p> <p>色相 Color 自然色 Natural</p> <p>ハウジング材質 Housing material SPS</p> <p>接点部めっき Plating on Contact Sn</p> <p>基板側めっき Plating on PCB side 4面Snめっき Sn plating on all sides</p> <p>基板接続 PCB mounting TH/THR</p> <p>基板固定 Mounted Way ねじ Screw</p> <p>梱包仕様 Packing Spec. トレイ Tray</p>				

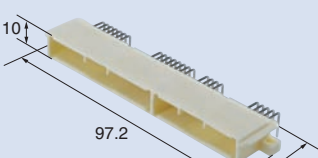
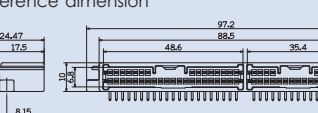
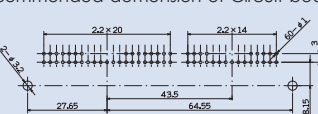
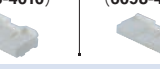
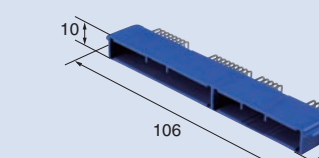
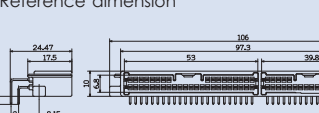
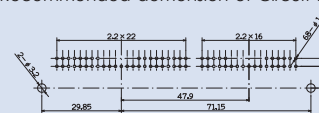

No.	端子サイズ Connector Size	極数 No. of Way Variation	シリーズ Series	防水性能 Sealing performance
4	0.64	36	TS	非防水 UnSealed
<p>Mコネクタ品番 (6098-6796) Connector M part No.</p>  <p>10 60.3 24.47</p>  <p>●参考寸法 Reference dimension</p>  <p>●基板推奨寸法 Recommended dimension of Circuit board</p>  <p>Fコネクタ品番 Connector F part No. (6098-4740)</p> 				
<p>用途 Use 自動車 Automobile</p> <p>嵌合方向 Mating direction 水平 Horizontal</p> <p>色相 Color 自然色 Natural</p> <p>ハウジング材質 Housing material PBT</p> <p>接点部めっき Plating on Contact Sn</p> <p>基板側めっき Plating on PCB side 4面Snめっき Sn plating on all sides</p> <p>基板接続 PCB mounting TH</p> <p>基板固定 Mounted Way ねじ Screw</p> <p>梱包仕様 Packing Spec. スティック Stick</p>				

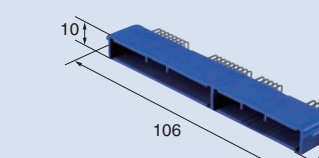
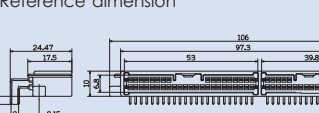
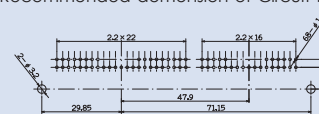

No.	端子サイズ Connector Size	極数 No. of Way Variation	シリーズ Series	防水性能 Sealing performance
5	0.64	36	TS	非防水 UnSealed
<b>Mコネクタ品番</b> (6098-6798) Connector M part No.				
				
<b>用途</b> Use 自動車 Automobile				
<b>嵌合方向</b> Mating direction 水平 Horizontal				
<b>色相</b> Color 自然色 Natural				
<b>ハウジング材質</b> Housing material SPS				
<b>参考寸法</b> Reference dimension				
				
<b>基板推奨寸法</b> Recommended demension of Circuit board				
				
<b>Fコネクタ品番</b> Connector F part No. (6098-4740)				
				
<b>用途</b> Use 自動車 Automobile				
<b>嵌合方向</b> Mating direction 水平 Horizontal				
<b>色相</b> Color 自然色 Natural				
<b>ハウジング材質</b> Housing material SPS				
<b>参考寸法</b> Reference dimension				
				
<b>用途</b> Use 自動車 Automobile				
<b>嵌合方向</b> Mating direction 水平 Horizontal				
<b>色相</b> Color 自然色 Natural				
<b>ハウジング材質</b> Housing material SPS				
<b>参考寸法</b> Reference dimension				
				
<b>基板推奨寸法</b> Recommended demension of Circuit board				
				
<b>Fコネクタ品番</b> Connector F part No. (6098-6682) (6098-6688) (6098-6694)				
				

No.	端子サイズ Connector Size	極数 No. of Way Variation	シリーズ Series	防水性能 Sealing performance
6	0.64	56(24+16+16)	TS	非防水 UnSealed
<b>Mコネクタ品番</b> (6098-6848) Connector M part No.				
				
<b>用途</b> Use 自動車 Automobile				
<b>嵌合方向</b> Mating direction 水平 Horizontal				
<b>色相</b> Color 自然色 Natural				
<b>ハウジング材質</b> Housing material SPS				
<b>参考寸法</b> Reference dimension				
				
<b>基板推奨寸法</b> Recommended demension of Circuit board				
				
<b>Fコネクタ品番</b> Connector F part No. (6098-6682) (6098-6688) (6098-6694)				
				

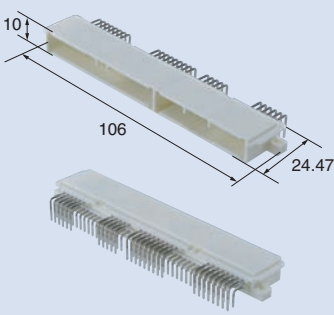
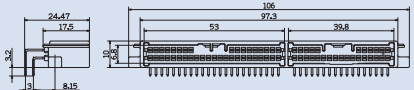
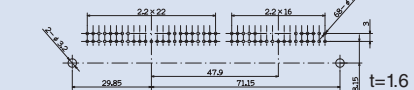

No.	端子サイズ Connector Size	極数 No. of Way Variation	シリーズ Series	防水性能 Sealing performance
7	0.64	60(36+24)	TS	非防水 UnSealed
<b>Mコネクタ品番</b> (6098-6803) Connector M part No.				
				
<b>用途</b> Use 自動車 Automobile				
<b>嵌合方向</b> Mating direction 水平 Horizontal				
<b>色相</b> Color 自然色 Natural				
<b>ハウジング材質</b> Housing material SPS				
<b>参考寸法</b> Reference dimension				
				
<b>基板推奨寸法</b> Recommended demension of Circuit board				
				
<b>Fコネクタ品番</b> Connector F part No. (6098-4010) (6098-4740)				
				
<b>用途</b> Use 自動車 Automobile				
<b>嵌合方向</b> Mating direction 水平 Horizontal				
<b>色相</b> Color 青 Blue				
<b>ハウジング材質</b> Housing material PBT				
<b>参考寸法</b> Reference dimension				
				
<b>用途</b> Use 自動車 Automobile				
<b>嵌合方向</b> Mating direction 水平 Horizontal				
<b>色相</b> Color 青 Blue				
<b>ハウジング材質</b> Housing material PBT				
<b>参考寸法</b> Reference dimension				
				
<b>基板推奨寸法</b> Recommended demension of Circuit board				
				
<b>Fコネクタ品番</b> Connector F part No. (6098-4756) (6098-4015)				
				

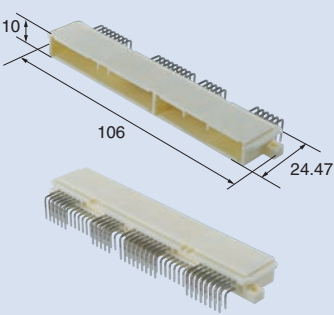
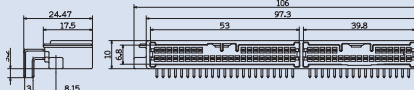
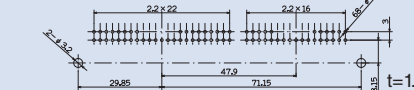
No.	端子サイズ Connector Size	極数 No. of Way Variation	シリーズ Series	防水性能 Sealing performance
8	0.64	68(40+28)	TS	非防水 UnSealed
<b>Mコネクタ品番</b> (6098-6810) Connector M part No.				
				
<b>用途</b> Use 自動車 Automobile				
<b>嵌合方向</b> Mating direction 水平 Horizontal				
<b>色相</b> Color 青 Blue				
<b>ハウジング材質</b> Housing material PBT				
<b>参考寸法</b> Reference dimension				
				
<b>基板推奨寸法</b> Recommended demension of Circuit board				
				
<b>Fコネクタ品番</b> Connector F part No. (6098-4756) (6098-4015)				
				

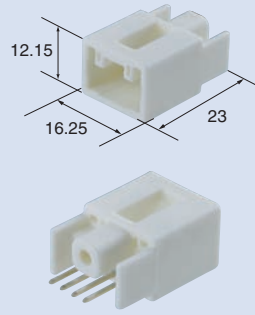
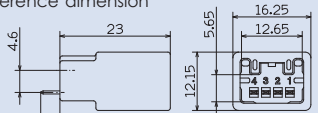
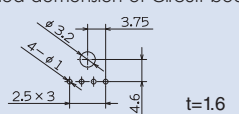
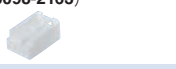

No.	端子サイズ Connector Size	極数 No. of Way Variation	シリーズ Series	防水性能 Sealing performance
9	0.64	68 (40+28)	TS	非防水 UnSealed
<p>Mコネクタ品番 (6098-6805) Connector M part No.</p>  <p>●参考寸法 Reference dimension</p>  <p>●基板推奨寸法 Recommended demension of Circuit board</p>  <p>Fコネクタ品番 Connector F part No. (6098-4756) (6098-4831)</p> 				
<p>用途 Use 自動車 Automobile</p> <p>嵌合方向 Mating direction 水平 Horizontal</p> <p>色相 Color 自然色 Natural</p> <p>ハウジング材質 Housing material PBT</p> <p>接点部めっき Plating on Contact Sn</p> <p>基板側めっき Plating on PCB side 4面Snめっき Sn plating on all sides</p> <p>基板接続 PCB mounting TH</p> <p>基板固定 Mounted Way ねじ Screw</p> <p>梱包仕様 Packing Spec. スティック Stick</p>				

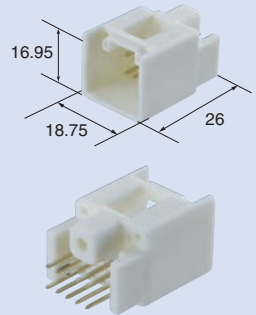
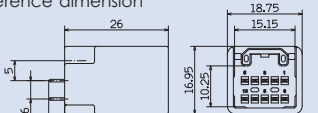
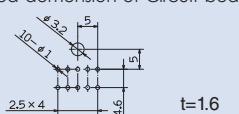

No.	端子サイズ Connector Size	極数 No. of Way Variation	シリーズ Series	防水性能 Sealing performance
10	0.64	68 (40+28)	TS	非防水 UnSealed
<p>Mコネクタ品番 (6098-7102) Connector M part No.</p>  <p>●参考寸法 Reference dimension</p>  <p>●基板推奨寸法 Recommended demension of Circuit board</p>  <p>Fコネクタ品番 Connector F part No. (6098-4756) (6098-4831)</p> 				
<p>用途 Use 自動車 Automobile</p> <p>嵌合方向 Mating direction 水平 Horizontal</p> <p>色相 Color 自然色 Natural</p> <p>ハウジング材質 Housing material SPS</p> <p>接点部めっき Plating on Contact Sn</p> <p>基板側めっき Plating on PCB side 4面Snめっき Sn plating on all sides</p> <p>基板接続 PCB mounting TH/THR</p> <p>基板固定 Mounted Way ねじ Screw</p> <p>梱包仕様 Packing Spec. スティック Stick</p>				

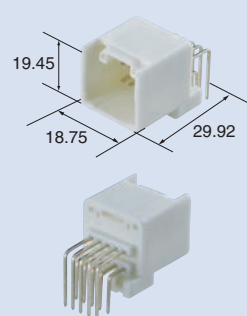
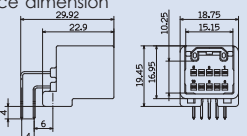
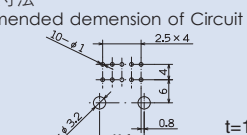

No.	端子サイズ Connector Size	極数 No. of Way Variation	シリーズ Series	防水性能 Sealing performance
11	1.0	4	TS	非防水 UnSealed
<p>Mコネクタ品番 (6098-2214) Connector M part No.</p>  <p>●参考寸法 Reference dimension</p>  <p>●基板推奨寸法 Recommended demension of Circuit board</p>  <p>Fコネクタ品番 Connector F part No. (6098-2163)</p> 				
<p>用途 Use 自動車 Automobile</p> <p>嵌合方向 Mating direction 垂直 Vertical Mount Type</p> <p>色相 Color 自然色 Natural</p> <p>ハウジング材質 Housing material PBT</p> <p>接点部めっき Plating on Contact Sn</p> <p>基板側めっき Plating on PCB side 2面Snめっき Sn plating on both sides</p> <p>基板接続 PCB mounting TH</p> <p>基板固定 Mounted Way ねじ Screw</p> <p>梱包仕様 Packing Spec. スティック Stick</p>				

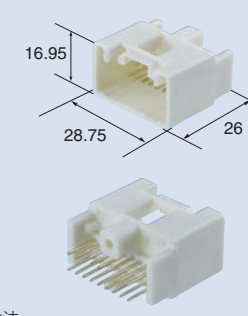
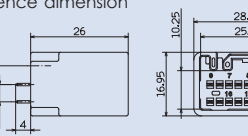
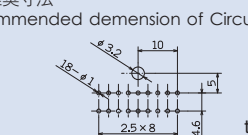

No.	端子サイズ Connector Size	極数 No. of Way Variation	シリーズ Series	防水性能 Sealing performance
12	1.0	10	TS	非防水 UnSealed
<p>Mコネクタ品番 (6098-2257) Connector M part No.</p>  <p>●参考寸法 Reference dimension</p>  <p>●基板推奨寸法 Recommended demension of Circuit board</p>  <p>Fコネクタ品番 Connector F part No. (6098-3015)</p> 				
<p>用途 Use 自動車 Automobile</p> <p>嵌合方向 Mating direction 垂直 Vertical Mount Type</p> <p>色相 Color 自然色 Natural</p> <p>ハウジング材質 Housing material PBT</p> <p>接点部めっき Plating on Contact Sn</p> <p>基板側めっき Plating on PCB side 2面Snめっき Sn plating on both sides</p> <p>基板接続 PCB mounting TH</p> <p>基板固定 Mounted Way ねじ Screw</p> <p>梱包仕様 Packing Spec. スティック Stick</p>				



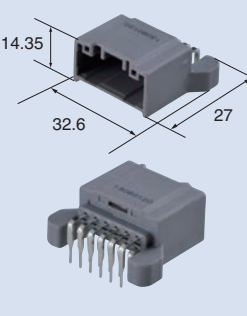
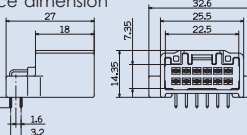
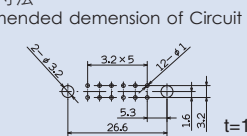



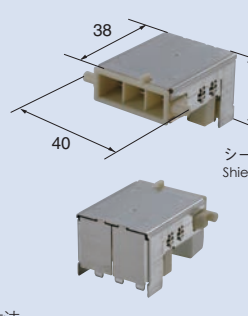
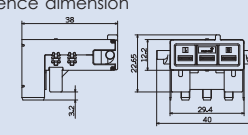
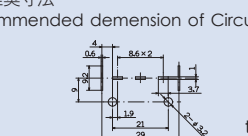

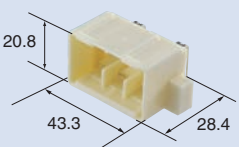

No.	端子サイズ Connector Size	極数 No. of Way Variation	シリーズ Series	防水性能 Sealing performance
13	1.0	10	TS	非防水 UnSealed
Mコネクタ品番 (6098-2434) Connector M part No. (6098-3353)  ●参考寸法 Reference dimension  ●基板推奨寸法 Recommended dimension of Circuit board  Fコネクタ品番 Connector F part No. (6098-3015) 				
		用途 Use		自動車 Automobile
		嵌合方向 Mating direction		水平 Horizontal
		色相 Color		自然色 Natural
		ハウジング材質 Housing material		PBT
		接点部めっき Plating on Contact		Sn
		基板側めっき Plating on PCB side		2面Snめっき Sn plating on both sides
		基板接続 PCB mounting		TH
		基板固定 Mounted Way		ねじ Screw
		梱包仕様 Packing Spec.		(6098-2434) スティック Stick
				(6098-3353) トレイ Tray

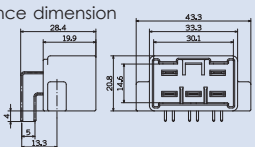
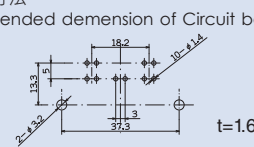

No.	端子サイズ Connector Size	極数 No. of Way Variation	シリーズ Series	防水性能 Sealing performance
14	1.0	18	TS	非防水 UnSealed
Mコネクタ品番 (6098-2165) Connector M part No. (6098-2444)  ●参考寸法 Reference dimension  ●基板推奨寸法 Recommended dimension of Circuit board  Fコネクタ品番 Connector F part No. (6098-3019) 				
		用途 Use		自動車 Automobile
		嵌合方向 Mating direction		垂直 Vertical Mount Type
		色相 Color		自然色 Natural
		ハウジング材質 Housing material		PBT
		接点部めっき Plating on Contact		Sn
		基板側めっき Plating on PCB side		2面Snめっき Sn plating on both sides
		基板接続 PCB mounting		TH
		基板固定 Mounted Way		ねじ Screw
		梱包仕様 Packing Spec.		(6098-2165) スティック Stick
				(6098-2444) トレイ Tray

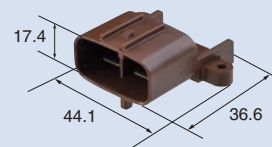

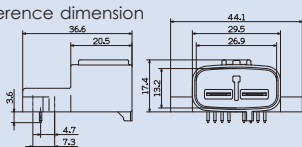
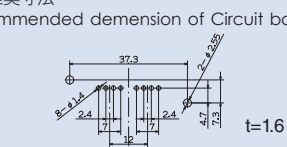

No.	端子サイズ Connector Size	極数 No. of Way Variation	シリーズ Series	防水性能 Sealing performance
15	1.5	12	DL	非防水 UnSealed
Mコネクタ品番 (6098-6210) Connector M part No. (6098-6883)  ●参考寸法 Reference dimension  ●基板推奨寸法 Recommended dimension of Circuit board  Fコネクタ品番 Connector F part No. (6098-5718) 				
		用途 Use		自動車 Automobile
		嵌合方向 Mating direction		水平 Horizontal
		色相 Color		灰 Gray
		ハウジング材質 Housing material		SPS
		接点部めっき Plating on Contact		Sn
		基板側めっき Plating on PCB side		4面Snめっき Sn plating on all sides
		基板接続 PCB mounting		TH
		基板固定 Mounted Way		ねじ Screw
		梱包仕様 Packing Spec.		(6098-6210) スティック Stick
				(6098-6883) トレイ Tray

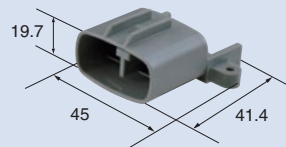
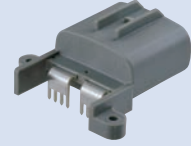
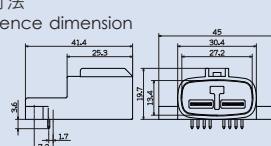
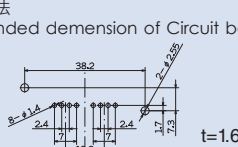

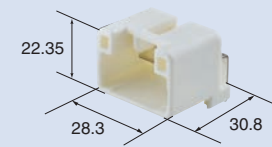

No.	端子サイズ Connector Size	極数 No. of Way Variation	シリーズ Series	防水性能 Sealing performance
16	4.8	3	TS	非防水 UnSealed
Mコネクタ品番 (6098-5569) Connector M part No. (6098-5797)  ●参考寸法 Reference dimension  ●基板推奨寸法 Recommended dimension of Circuit board  Fコネクタ品番 Connector F part No. (6098-5346) 				
		用途 Use		自動車 Automobile
		嵌合方向 Mating direction		水平 Horizontal
		色相 Color		自然色 Natural
		ハウジング材質 Housing material		SPS
		接点部めっき Plating on Contact		Sn
		基板側めっき Plating on PCB side		4面Snめっき Sn plating on all sides
		基板接続 PCB mounting		TH
		基板固定 Mounted Way		ねじ Screw
		梱包仕様 Packing Spec.		(6098-5569) スティック Stick
				(6098-5797) スティック(輸出用) Stick (For exports)

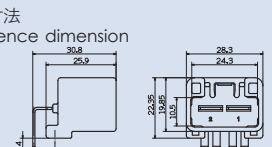
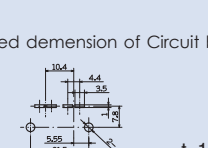

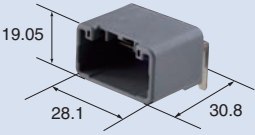

No.	端子サイズ Connector Size	極数 No. of Way Variation	シリーズ Series	防水性能 Sealing performance
17	4.8	5	HE	非防水 UnSealed
<p>Mコネクタ品番 (6098-4688) Connector M part No.</p>  <p>20.8 43.3 28.4</p>  <p>●参考寸法 Reference dimension</p>  <p>●基板推奨寸法 Recommended dimension of Circuit board</p>  <p>Fコネクタ品番 Connector F part No. (6098-4667)</p> 				
用途 Use 自動車 Automobile				
嵌合方向 Mating direction 水平 Horizontal				
色相 Color 自然色 Natural				
ハウジング材質 Housing material SPS				
接点部めっき Plating on Contact Sn				
基板側めっき Plating on PCB side 2面Snめっき Sn plating on both sides				
基板接続 PCB mounting TH				
基板固定 Mounted Way ねじ Screw				
梱包仕様 Packing Spec. トレイ Tray				

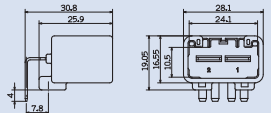
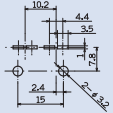

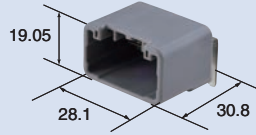

No.	端子サイズ Connector Size	極数 No. of Way Variation	シリーズ Series	防水性能 Sealing performance
18	7.7	2	HW	防水 Sealed
<p>Mコネクタ品番 (6188-4948) Connector M part No.</p>  <p>17.4 44.1 36.6</p>  <p>●参考寸法 Reference dimension</p>  <p>●基板推奨寸法 Recommended dimension of Circuit board</p>  <p>Fコネクタ品番 Connector F part No. (6189-7022)</p> 				
用途 Use 自動車 Automobile				
嵌合方向 Mating direction 水平 Horizontal				
色相 Color 茶 Brown				
ハウジング材質 Housing material PBT				
接点部めっき Plating on Contact Sn				
基板側めっき Plating on PCB side 2面Snめっき Sn plating on both sides				
基板接続 PCB mounting TH				
基板固定 Mounted Way ねじ Screw				
梱包仕様 Packing Spec. トレイ Tray				

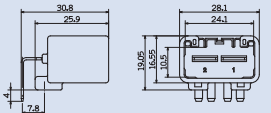
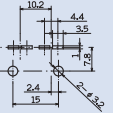

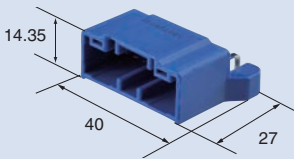

No.	端子サイズ Connector Size	極数 No. of Way Variation	シリーズ Series	防水性能 Sealing performance
19	7.7	2	DL	防水 Sealed
<p>Mコネクタ品番 (6188-4949) Connector M part No.</p>  <p>19.7 45 41.4</p>  <p>●参考寸法 Reference dimension</p>  <p>●基板推奨寸法 Recommended dimension of Circuit board</p>  <p>Fコネクタ品番 Connector F part No. (6189-7023)</p> 				
用途 Use 自動車 Automobile				
嵌合方向 Mating direction 水平 Horizontal				
色相 Color 灰 Gray				
ハウジング材質 Housing material PBT				
接点部めっき Plating on Contact Sn				
基板側めっき Plating on PCB side 2面Snめっき Sn plating on both sides				
基板接続 PCB mounting TH				
基板固定 Mounted Way ねじ Screw				
梱包仕様 Packing Spec. トレイ Tray				

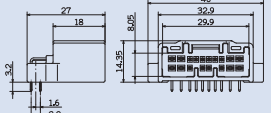
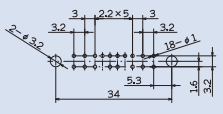

No.	端子サイズ Connector Size	極数 No. of Way Variation	シリーズ Series	防水性能 Sealing performance
20	8.0	2	TS	非防水 UnSealed
<p>Mコネクタ品番 (6098-2893) Connector M part No.</p>  <p>22.35 28.3 30.8</p>  <p>●参考寸法 Reference dimension</p>  <p>●基板推奨寸法 Recommended dimension of Circuit board</p>  <p>Fコネクタ品番 Connector F part No. (6098-1104)</p> 				
用途 Use 自動車 Automobile				
嵌合方向 Mating direction 水平 Horizontal				
色相 Color 自然色 Natural				
ハウジング材質 Housing material PBT				
接点部めっき Plating on Contact Sn				
基板側めっき Plating on PCB side 2面Snめっき Sn plating on both sides				
基板接続 PCB mounting TH				
基板固定 Mounted Way ねじ Screw				
梱包仕様 Packing Spec. スティック Stick				

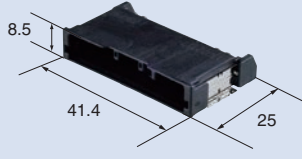

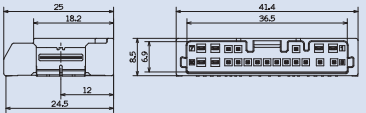
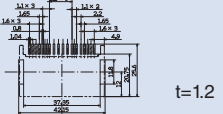
No.	端子サイズ Connector Size	極数 No. of Way Variation	シリーズ Series	防水性能 Sealing performance
21	8.0	2	TS	非防水 UnSealed
<p>Mコネクタ品番 (6098-2895) Connector M part No. (6098-2895)</p>  <p>19.05 28.1 30.8</p>  <p>●参考寸法 Reference dimension</p>  <p>●基板推奨寸法 Recommended dimension of Circuit board</p>  <p>t=1.6</p> <p>Fコネクタ品番 Connector F part No. (6098-2897)</p> 				
<p>用途 Use 自動車 Automobile</p> <p>嵌合方向 Mating direction 水平 Horizontal</p> <p>色相 Color 灰 Gray</p> <p>ハウジング材質 Housing material PBT</p> <p>接点部めっき Plating on Contact Sn</p> <p>基板側めっき Plating on PCB side 2面Snめっき Sn plating on both sides</p> <p>基板接続 PCB mounting TH</p> <p>基板固定 Mounted Way ねじ Screw</p> <p>梱包仕様 Packing Spec. スティック Stick</p>				

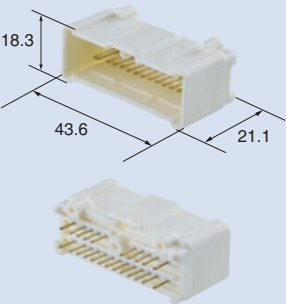
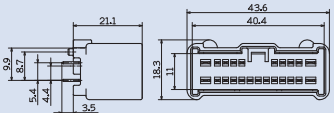
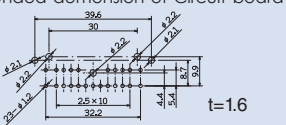

No.	端子サイズ Connector Size	極数 No. of Way Variation	シリーズ Series	防水性能 Sealing performance
22	8.0	2	HT	非防水 UnSealed
<p>Mコネクタ品番 (6098-7493) Connector M part No. (6098-7493)</p>  <p>19.05 28.1 30.8</p>  <p>●参考寸法 Reference dimension</p>  <p>●基板推奨寸法 Recommended dimension of Circuit board</p>  <p>t=1.6</p> <p>Fコネクタ品番 Connector F part No. (6098-2897)</p> 				
<p>用途 Use 自動車 Automobile</p> <p>嵌合方向 Mating direction 水平 Horizontal</p> <p>色相 Color 灰 Gray</p> <p>ハウジング材質 Housing material SPS</p> <p>接点部めっき Plating on Contact Sn</p> <p>基板側めっき Plating on PCB side 2面Snめっき Sn plating on both sides</p> <p>基板接続 PCB mounting TH</p> <p>基板固定 Mounted Way ねじ Screw</p> <p>梱包仕様 Packing Spec. トレイ Tray</p>				

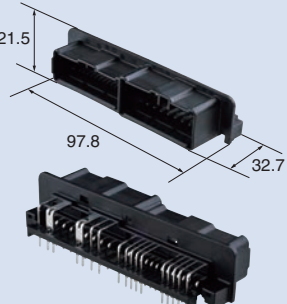
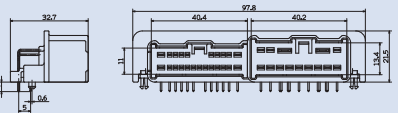
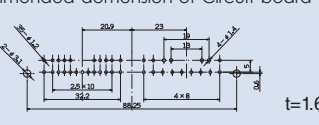

No.	端子サイズ Connector Size	極数 No. of Way Variation	シリーズ Series	防水性能 Sealing performance
23	0.64+1.5	10+8	DL	非防水 UnSealed
<p>Mコネクタ品番 (6098-6212) Connector M part No. (6098-6212)</p> <p>(6098-6885)</p>  <p>14.35 40 27</p>  <p>●参考寸法 Reference dimension</p>  <p>●基板推奨寸法 Recommended dimension of Circuit board</p>  <p>t=1.6</p> <p>Fコネクタ品番 Connector F part No. (6098-5611)</p> 				
<p>用途 Use 自動車 Automobile</p> <p>嵌合方向 Mating direction 水平 Horizontal</p> <p>色相 Color 青 Blue</p> <p>ハウジング材質 Housing material SPS</p> <p>接点部めっき Plating on Contact Sn</p> <p>基板側めっき Plating on PCB side 4面Snめっき Sn plating on all sides</p> <p>基板接続 PCB mounting TH</p> <p>基板固定 Mounted Way ねじ Screw</p> <p>梱包仕様 Packing Spec. スティック Stick</p> <p>(6098-6212)</p> <p>(6098-6885)</p> <p>トレイ Tray</p>				



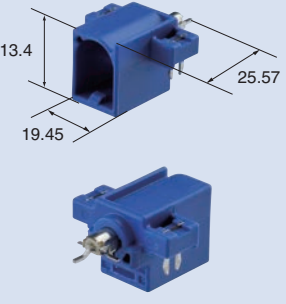
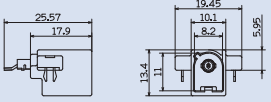
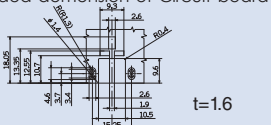

No.	端子サイズ Connector Size	極数 No. of Way Variation	シリーズ Series	防水性能 Sealing performance
24	0.64+1.5	14+6	TS	非防水 UnSealed
<p>Mコネクタ品番 (6098-6869) Connector M part No. (6098-6869)</p>  <p>8.5 41.4 25</p>  <p>●参考寸法 Reference dimension</p>  <p>●基板推奨寸法 Recommended dimension of Circuit board</p>  <p>t=1.2</p> <p>Fコネクタ品番 Connector F part No. (6098-6876)</p> 				
<p>用途 Use 自動車 Automobile</p> <p>嵌合方向 Mating direction 水平 Horizontal</p> <p>色相 Color 黒 Black</p> <p>ハウジング材質 Housing material LCP</p> <p>接点部めっき Plating on Contact Sn</p> <p>基板側めっき Plating on PCB side 4面Snめっき Sn plating on all sides</p> <p>基板接続 PCB mounting SMT</p> <p>基板固定 Mounted Way ペグ Peg</p> <p>梱包仕様 Packing Spec. トレイ Tray</p>				

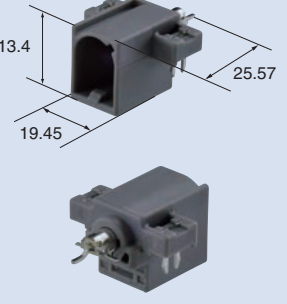
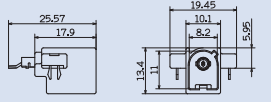
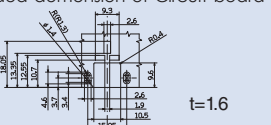

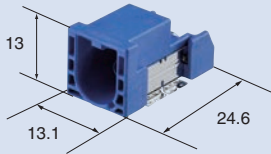

No.	端子サイズ Connector Size	極数 No. of Way Variation	シリーズ Series	防水性能 Sealing performance
25	1.0+2.3	19+4	HE	非防水 UnSealed
<p>Mコネクタ品番 (6098-3572) Connector M part No.</p>  <p>18.3 43.6 21.1</p> <p>●参考寸法 Reference dimension</p>  <p>●基板推奨寸法 Recommended dimension of Circuit board</p>  <p>Fコネクタ品番 Connector F part No. (6098-3571)</p> 				
用途 Use 自動車 Automobile				
嵌合方向 Mating direction 垂直 Vertical Mount Type				
色相 Color 自然色 Natural				
ハウジング材質 Housing material PBT				
接点部めっき Plating on Contact Sn				
基板側めっき Plating on PCB side 2面Snめっき Sn plating on both sides				
基板接続 PCB mounting TH				
基板固定 Mounted Way ねじ Screw				
梱包仕様 Packing Spec. トレイ Tray				

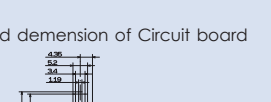
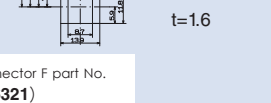
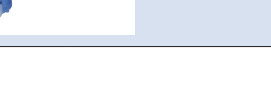

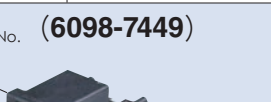
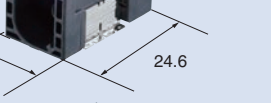

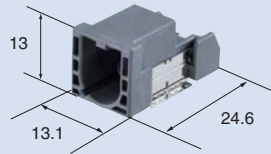
No.	端子サイズ Connector Size	極数 No. of Way Variation	シリーズ Series	防水性能 Sealing performance
26	1.0+2.3+4.8	19+16+2	HE	非防水 UnSealed
<p>Mコネクタ品番 (6098-6568) Connector M part No.</p>  <p>21.5 97.8 32.7</p> <p>●参考寸法 Reference dimension</p>  <p>●基板推奨寸法 Recommended dimension of Circuit board</p>  <p>Fコネクタ品番 Connector F part No. (6098-4366) (6098-4367)</p> 				
用途 Use 自動車 Automobile				
嵌合方向 Mating direction 水平 Horizontal				
色相 Color 黒 Black				
ハウジング材質 Housing material PBT				
接点部めっき Plating on Contact Sn				
基板側めっき Plating on PCB side 4面Snめっき Sn plating on all sides				
基板接続 PCB mounting TH				
基板固定 Mounted Way ねじ Screw				
梱包仕様 Packing Spec. トレイ Tray				

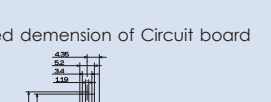
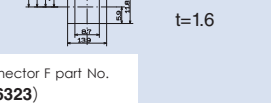
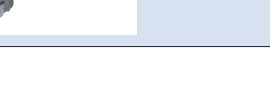

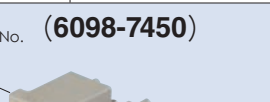
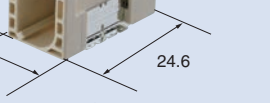

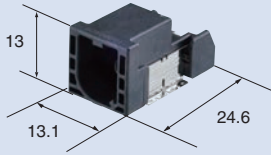
No.	端子サイズ Connector Size	極数 No. of Way Variation	シリーズ Series	防水性能 Sealing performance
27	HFCⅢ	1	HFC	非防水 UnSealed
<p>Mコネクタ品番 (6098-6157) Connector M part No.</p>  <p>13.4 19.45 25.57</p> <p>●参考寸法 Reference dimension</p>  <p>●基板推奨寸法 Recommended dimension of Circuit board</p>  <p>Fコネクタ品番 Connector F part No. (6098-6321)</p> 				
用途 Use 自動車 Automobile				
嵌合方向 Mating direction 水平 Horizontal				
色相 Color 青 Blue				
ハウジング材質 Housing material SPS				
接点部めっき Plating on Contact Au				
基板側めっき Plating on PCB side 4面Snめっき Sn plating on all sides				
基板接続 PCB mounting 手はんだ付け Hand Soldering				
基板固定 Mounted Way スナップピン Snapshot pin				
梱包仕様 Packing Spec. トレイ Tray				

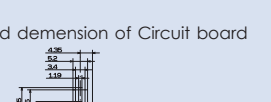
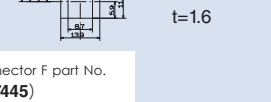

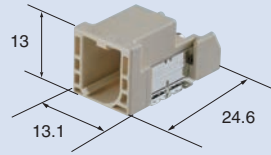

No.	端子サイズ Connector Size	極数 No. of Way Variation	シリーズ Series	防水性能 Sealing performance
28	HFCⅢ	1	HFC	非防水 UnSealed
<p>Mコネクタ品番 (6098-6159) Connector M part No.</p>  <p>13.4 19.45 25.57</p> <p>●参考寸法 Reference dimension</p>  <p>●基板推奨寸法 Recommended dimension of Circuit board</p>  <p>Fコネクタ品番 Connector F part No. (6098-6323)</p> 				
用途 Use 自動車 Automobile				
嵌合方向 Mating direction 水平 Horizontal				
色相 Color 灰 Gray				
ハウジング材質 Housing material SPS				
接点部めっき Plating on Contact Au				
基板側めっき Plating on PCB side 4面Snめっき Sn plating on all sides				
基板接続 PCB mounting 手はんだ付け Hand Soldering				
基板固定 Mounted Way スナップピン Snapshot pin				
梱包仕様 Packing Spec. トレイ Tray				

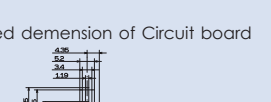
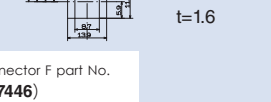

No.	端子サイズ Connector Size	極数 No. of Way Variation	シリーズ Series	防水性能 Sealing performance
29	HFCⅢ	1	HFC	非防水 UnSealed
Mコネクタ品番 (6098-7132) Connector M part No.				
		用途 Use 自動車 Automobile		
		嵌合方向 Mating direction 水平 Horizontal		
		色相 Color 青 Blue		
		ハウジング材質 Housing material LCP		
		接点部めっき Plating on Contact Au		
		基板側めっき Plating on PCB side 4面Snめっき Sn plating on all sides		
		基板接続 PCB mounting SMT		
		基板固定 Mounted Way ペグ Peg		
		梱包仕様 Packing Spec. エンボステープ Emboss Tape		
●参考寸法 Reference dimension				
●基板推奨寸法 Recommended dimension of Circuit board				
Fコネクタ品番 Connector F part No. (6098-6321)				

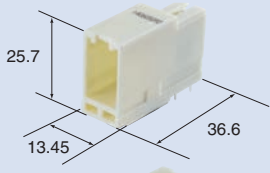

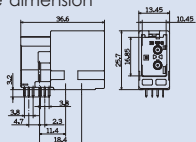
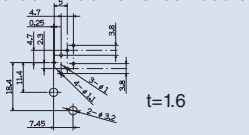

No.	端子サイズ Connector Size	極数 No. of Way Variation	シリーズ Series	防水性能 Sealing performance
30	HFCⅢ	1	HFC	非防水 UnSealed
Mコネクタ品番 (6098-7134) Connector M part No.				
		用途 Use 自動車 Automobile		
		嵌合方向 Mating direction 水平 Horizontal		
		色相 Color 灰 Gray		
		ハウジング材質 Housing material LCP		
		接点部めっき Plating on Contact Au		
		基板側めっき Plating on PCB side 4面Snめっき Sn plating on all sides		
		基板接続 PCB mounting SMT		
		基板固定 Mounted Way ペグ Peg		
		梱包仕様 Packing Spec. エンボステープ Emboss Tape		
●参考寸法 Reference dimension				
●基板推奨寸法 Recommended dimension of Circuit board				
Fコネクタ品番 Connector F part No. (6098-6323)				

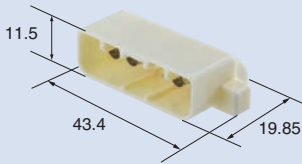
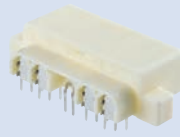
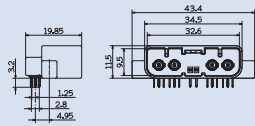
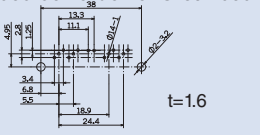

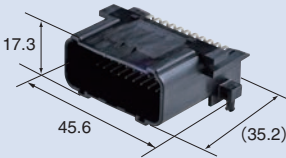

No.	端子サイズ Connector Size	極数 No. of Way Variation	シリーズ Series	防水性能 Sealing performance
31	HFCⅢ	1	HFC	非防水 UnSealed
Mコネクタ品番 (6098-7449) Connector M part No.				
		用途 Use 自動車 Automobile		
		嵌合方向 Mating direction 水平 Horizontal		
		色相 Color 黒 Black		
		ハウジング材質 Housing material LCP		
		接点部めっき Plating on Contact Au		
		基板側めっき Plating on PCB side 4面Snめっき Sn plating on all sides		
		基板接続 PCB mounting SMT		
		基板固定 Mounted Way ペグ Peg		
		梱包仕様 Packing Spec. エンボステープ Emboss Tape		
●参考寸法 Reference dimension				
●基板推奨寸法 Recommended dimension of Circuit board				
Fコネクタ品番 Connector F part No. (6098-7445)				

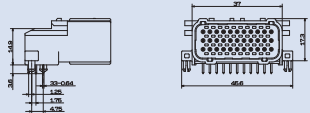
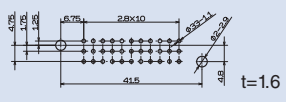

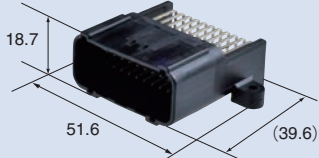

No.	端子サイズ Connector Size	極数 No. of Way Variation	シリーズ Series	防水性能 Sealing performance
32	HFCⅢ	1	HFC	非防水 UnSealed
Mコネクタ品番 (6098-7450) Connector M part No.				
		用途 Use 自動車 Automobile		
		嵌合方向 Mating direction 水平 Horizontal		
		色相 Color 自然色 Natural		
		ハウジング材質 Housing material LCP		
		接点部めっき Plating on Contact Au		
		基板側めっき Plating on PCB side 4面Snめっき Sn plating on all sides		
		基板接続 PCB mounting SMT		
		基板固定 Mounted Way ペグ Peg		
		梱包仕様 Packing Spec. エンボステープ Emboss Tape		
●参考寸法 Reference dimension				
●基板推奨寸法 Recommended dimension of Circuit board				
Fコネクタ品番 Connector F part No. (6098-7446)				

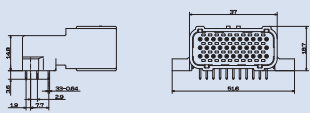
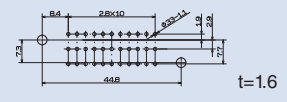
No.	端子サイズ Connector Size	極数 No. of Way Variation	シリーズ Series	防水性能 Sealing performance
33	HFCⅢ+0.64	2+1	HFC	非防水 UnSealed
<p>Mコネクタ品番 (6098-5761) Connector M part No. (6098-5761)</p>   <p>●参考寸法 Reference dimension</p>  <p>●基板推奨寸法 Recommended dimension of Circuit board</p>  <p>Fコネクタ品番 Connector F part No. (6098-6037) メス端子:コンデンサ内蔵 Female terminal With built-in condenser</p> 				
<p>用途 Use 自動車 Automobile</p> <p>嵌合方向 Mating direction 水平 Horizontal</p> <p>色相 Color 自然色 Natural</p> <p>ハウジング材質 Housing material SPS</p> <p>接点部めっき Plating on Contact HFCⅢ: Au 0.64: Sn</p> <p>基板側めっき Plating on PCB side 4面Snめっき Sn plating on all sides</p> <p>基板接続 PCB mounting TH</p> <p>基板固定 Mounted Way ねじ Screw</p> <p>梱包仕様 Packing Spec. スティック Stick</p>				

No.	端子サイズ Connector Size	極数 No. of Way Variation	シリーズ Series	防水性能 Sealing performance
34	HFCⅢ+0.64	4+2	HFC	非防水 UnSealed
<p>Mコネクタ品番 (6098-6700) Connector M part No. (6098-6700)</p>   <p>●参考寸法 Reference dimension</p>  <p>●基板推奨寸法 Recommended dimension of Circuit board</p>  <p>Fコネクタ品番 Connector F part No. (6098-6702)</p> 				
<p>用途 Use 自動車 Automobile</p> <p>嵌合方向 Mating direction 水平 Horizontal</p> <p>色相 Color 自然色 Natural</p> <p>ハウジング材質 Housing material SPS</p> <p>接点部めっき Plating on Contact HFCⅢ: Au 0.64: Sn</p> <p>基板側めっき Plating on PCB side 4面Snめっき Sn plating on all sides</p> <p>基板接続 PCB mounting TH</p> <p>基板固定 Mounted Way ねじ Screw</p> <p>梱包仕様 Packing Spec. トレイ Tray</p>				

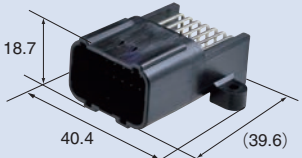
No.	端子サイズ Connector Size	極数 No. of Way Variation	シリーズ Series	防水性能 Sealing performance
35	0.64	33	—	防水 Sealed
<p>Mコネクタ品番 (6188-4871) Connector M part No.</p>   <p>●参考寸法 Reference dimension</p>  <p>●基板推奨寸法 Recommended dimension of Circuit board</p>  <p>Fコネクタ品番 Connector F part No. (6189-7106)</p> 				
<p>用途 Use 自動二輪車 Motorcycle</p> <p>嵌合方向 Mating direction 水平 Horizontal</p> <p>色相 Color 黒 Black</p> <p>ハウジング材質 Housing material PBT</p> <p>接点部めっき Plating on Contact Sn</p> <p>基板側めっき Plating on PCB side 2面Snめっき Sn plating on both sides</p> <p>基板接続 PCB mounting TH</p> <p>基板固定 Mounted Way ボードロック Board rock</p> <p>梱包仕様 Packing Spec. スティック Stick</p>				

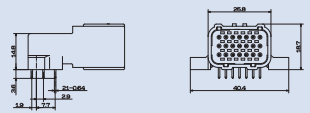
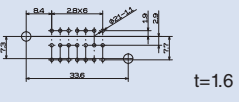
No.	端子サイズ Connector Size	極数 No. of Way Variation	シリーズ Series	防水性能 Sealing performance
36	0.64	33	—	防水 Sealed
<p>Mコネクタ品番 (6188-0800) Connector M part No.</p>   <p>●参考寸法 Reference dimension</p>  <p>●基板推奨寸法 Recommended dimension of Circuit board</p>  <p>Fコネクタ品番 Connector F part No. (6189-7106)</p> 				
<p>用途 Use 自動二輪車 Motorcycle</p> <p>嵌合方向 Mating direction 水平 Horizontal</p> <p>色相 Color 黒 Black</p> <p>ハウジング材質 Housing material PBT</p> <p>接点部めっき Plating on Contact Sn</p> <p>基板側めっき Plating on PCB side 2面Snめっき Sn plating on both sides</p> <p>基板接続 PCB mounting TH</p> <p>基板固定 Mounted Way ねじ Screw</p> <p>梱包仕様 Packing Spec. トレイ Tray</p>				

No.	端子サイズ Connector Size	極数 No. of Way Variation	シリーズ Series	防水性能 Sealing performance
37	0.64	21	—	防水 Sealed
<p>Mコネクタ品番 (6188-0790) Connector M part No.</p>   <p>●参考寸法 Reference dimension</p>  <p>●基板推奨寸法 Recommended dimension of Circuit board</p>  <p>Fコネクタ品番 Connector F part No. (6189-7108)</p> 				
<p>用途 Use 自動二輪車 Motorcycle</p> <p>嵌合方向 Mating direction 水平 Horizontal</p> <p>色相 Color 黒 Black</p> <p>ハウジング材質 Housing material PBT</p> <p>接点部めっき Plating on Contact Sn</p> <p>基板側めっき Plating on PCB side 2面Snめっき Sn plating on both sides</p> <p>基板接続 PCB mounting TH</p> <p>基板固定 Mounted Way ねじ Screw</p> <p>梱包仕様 Packing Spec. トレイ Tray</p>				

# 【参考】梱包仕様

【Reference】Packing speck

## ①スティック Stick

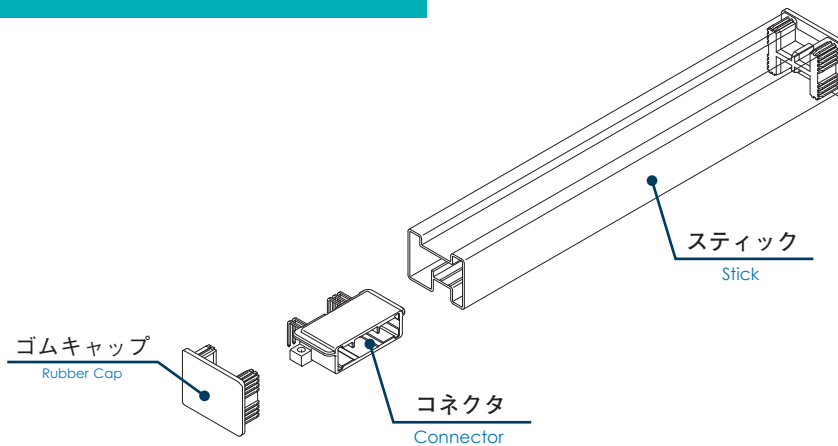

## ②トレイ Tray

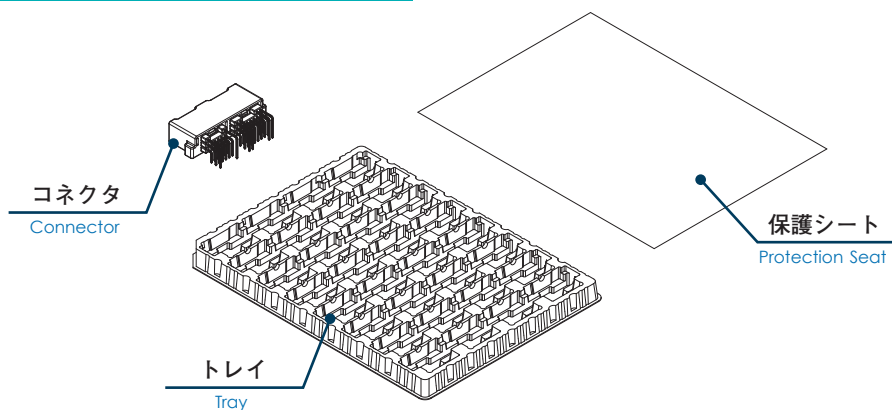

## ③エンボステープ Emboss Tape

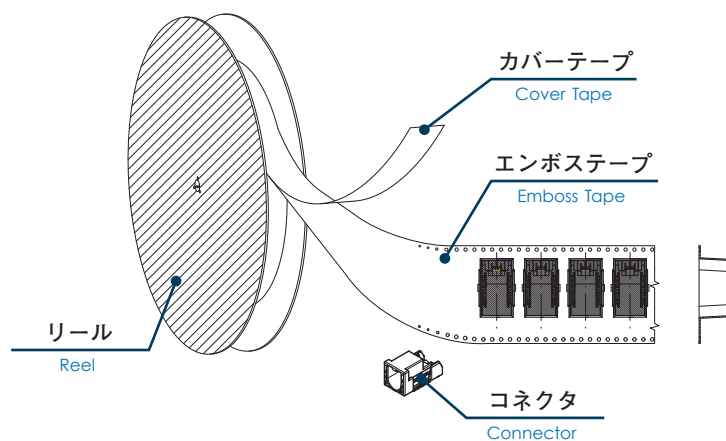



memo



Lined writing area consisting of 20 horizontal lines.



memo



A series of 20 horizontal lines spaced evenly down the page, providing a template for writing.



## ⚠ WARNING <禁止事項>

- 既定の電流値を超えて使用しないでください。
- 割れたりヒビが入ったハウジングは使用しないでください。
- 変形したり、錆びたターミナルは使用しないでください。

- Do not exceed prescribed current to the connectors.
- Do not use a broken or cracked housing.
- Do not use a deformed or rusty terminal.

**発熱・発火の恐れがあります！**  
**Which may result in overheating or fire.**

## ⚠ CAUTION <ご使用上の注意事項>

- コネクタ選定にあたっては、使用環境、組み付け条件等を弊社営業担当にご相談頂き、用途に適合した製品をお選びください。
- コネクタの電流容量、仕様、性能は極数、使用電線サイズ、周囲温度など、使用環境の可変値によって数値が大きく変わります。  
本カタログに掲載の電流容量 (= 最大電流値) は、下記条件でのターミナル単体の数値であり、実際にハウジングに組み付けて使用したときの性能を保証するものではありません。  
(条件：最大電線サイズ仕様、40℃温度上昇時、単極通電)  
各製品の詳しい電気特性は、シリーズ毎の「仕様書」でご確認ください。
- 当社ではコネクタの性能に関する「仕様書」、及びコネクタの使用法、取扱方法、注意点に関する「取扱説明書」をシリーズ毎に用意しております。コネクタ選定、ご使用に際してはそれらを必ずお読み頂いた上で正しくご使用ください。
- 適用治工具（ターミナル抜き治具等）のご要望は弊社営業担当にご相談ください。
- 各コネクタには基板穴寸法を掲載しているものがありますが、あくまで参考図としてご参照願います。
- 記載商品にはお客様との共同開発品が一部含まれております。当該お客様向け以外の販売につきましても、事前承認が必要となりますので、弊社営業担当にお問い合わせ下さるようお願い申し上げます。
- 本カタログは弊社基板用コネクタの代表的なアイテムを掲載しています。掲載品以外の色相、リブ違い、シリーズ、極数のラインナップもあり、またご要望に応じた開発を行うことも可能ですので、コネクタ選定の際には是非弊社営業担当へお問い合わせください。

- To select a suitable connector, please consult with our sales staff about operating environment, mounting conditions, and other information.
- The current capacity, specifications, and performance of a connector may significantly vary depending on changes in variable elements in the operating environment, such as the number of ways, wire size, ambient temperature, etc.  
The current capacity (maximum) stated in this catalogue applies to a single terminal under the conditions described below, and is not guaranteed when the terminal is inserted into a housing.  
(Conditions: Maximum wire size specifications, temperature at 40 °C, and single pole current flow)  
For detailed electrical characteristics of each product, see the "Specifications" of the relevant series.
- We have "Specifications" for connector performance and "Instruction Manuals" for connector usage, handling, and precautions, which are available for each connector series.  
Please be sure to read these in advance to select the appropriate connector and to use it correctly.
- Please consult with our sales staff when requesting applicable tools and jigs (terminal removal jigs etc.) .
- Although some connector specifications include drawings showing mounting holes of PCB, these drawings are provided only for reference.
- This catalogue include the parts that were designed and developed jointly with a customer and require prior approval before sales. Please contact our sales staff for details.
- This catalogue includes the main items of our PCB connectors. In addition to the items listed, we have a line of connectors available for sales that vary in color/rib/series/number of ways. Our staff can also develop products that meet your individual needs. Please contact our sales staff when selecting connectors.

※カタログの内容は製品の改良等により予告なく変更される事があります。  
製品ご使用の際は、弊社営業担当に「お客様用図面」「仕様書」「取扱説明書」をご請求ください。  
上記についての詳細は弊社営業担当にお問い合わせください。

\*The contents of this brochure may be subject to change without notice such as due to product modification.  
Before using the product, please obtain a "customer drawing"  
"Specifications" "Instruction Manuals" from our sales staff.  
Please contact our sales staff for details.

# Connect with the Best



## 住友電装株式会社 Sumitomo Wiring Systems, Ltd.

### 【本社】

三重県四日市市浜田町5番28号 〒510-8528  
TEL(059)354-6200 FAX(059)354-6318

### 【東京本社】

東京都港区元赤坂1丁目3番13号(赤坂センタービルディング11階) 〒107-0051  
TEL(03)6384-5600 FAX(03)6384-5601

### 営業拠点一覧

#### 【国内営業統轄部】

##### 名古屋営業部

名古屋市区西牛島町6番1号(名古屋ルーセントタワー17階) 〒451-6017  
TEL(052)582-6222 FAX(052)582-6228

##### 東京営業部

東京都港区元赤坂1丁目3番13号(赤坂センタービルディング11階) 〒107-0051  
TEL(03)6384-5604 FAX(03)6384-5608

##### 大阪営業部

大阪府大阪市中央区今橋4丁目3番18号(HK今橋ビル3階) 〒541-0042  
TEL(06)6229-1960 FAX(06)6229-1965

#### 【海外営業統轄部】

##### 開発営業部

東京都港区元赤坂1丁目3番13号(赤坂センタービルディング11階) 〒107-0051  
TEL(03)6384-5609 FAX(03)6384-5610

##### 海外ビジネス推進部

名古屋市区西牛島町6番1号(名古屋ルーセントタワー17階) 〒451-6017  
TEL(052)582-6221 FAX(052)582-6272

### Global Network-Sales Office Locations-

#### Sumitomo Wiring Systems(U.S.A.) Inc. 「U.S.A.」 [SWS-USA]

39555 Orchard Hill Place Suite L60 Novi, MI 48375-5523 U.S.A.  
TEL(1)248-347-9450 FAX(1)248-347-9451

#### SWS China Ltd. 「China」 [SWS-C]

Room 1503-1506, TowerB, City Center of Shanghai, 100 Zunyi Rd.,  
Chang Ning District, Shanghai, China 2000051  
TEL(86)21-2028-6588 FAX(86)21-2024-3251

#### Hong Kong Wiring Systems, Ltd. 「China」 [HKWS]

Suites 1701-06, 17th Floor, Chinachem TsuenWan Plaza,  
455-457 Castle Peak Road, Tsuen Wan, N.T., HongKong  
TEL(852)2411-0806 FAX(852)2413-6098

#### SWS-Korea Co., Ltd. 「Korea」 [SWS-K]

402, 8 Seongnam-daero 331beon-gil, Bundang-gu,  
Seongnam-si, Gyeonggi-do, Korea (463-844)  
TEL(82)31-719-9710 FAX(82)31-719-9719

#### SWS Sales & Marketing(Thailand) Co., Ltd. 「Thailand」 [SWS-T]

33/4 The 9th Towers, Grand Rama 9, Tower A, 15th Fl., RamaRd.,  
Huaykwang, Huaykwang, Bangkok 10310 Thailand  
TEL(66)02-001-4301 FAX(66)02-001-4310

#### SEWS-Components & Electronics Europe, KFT. 「Hungary」 [SEWS-CEKFT]

Europe utca 12. BILK L1 Building Budapest 1239, Hungary  
TEL(36)1889-0500 FAX(36)1889-0501

<http://www.sws.co.jp>

本カタログの内容は、2017年6月現在のものです。  
自然保護のため、再生紙を使用しています。L1706

Printed on recycled paper for conservation of the nature.  
Printed in Japan, as of June. 2017L1706D1000