

HX SEALED SERIES

The image shows several HX sealed connectors of different colors (white, grey, and tan) and sizes, arranged on a dark, textured surface. The surface is covered with numerous water droplets of varying sizes, creating a sense of moisture and highlighting the 'sealed' nature of the connectors. The connectors have multiple wires protruding from them, and some are shown in a partially inserted state into their respective housings.

Features

The HX sealed connector series is the highly reliable improved version of the conventional HW sealed series, with a mechanism that detects when terminals are not inserted completely.

This series consists of 1.0mm · 1.5mm · 2.3mm types (0.64mm · 1.0mm · 1.5mm · 2.3mm · 4.8mm types for the hybrid model) classified according to terminal size, supporting use in a variety of control circuits and low power circuits.

- The connector mechanism only allows the retainer to be set when the terminal is completely inserted.
- The hybrid model can be directly secured to a bracket on the car body, but this is only possible when the locking mechanism ensures the connectors are completely engaged, preventing semi-engagement.
- RoHS/ELV Compliant

特点

HX 系列是将以往的 HW 系列改良后、提高了可信性的接插件。

具有检测端子插入不足的结构。

按照端子尺寸划分为1.0mm · 1.5mm · 2.3mm (混合为 0.64mm · 1.0mm · 1.5mm · 2.3mm · 4.8mm)，可以应用于各种控制回路与低功率回路。

- 拥有当端子在半插入状态时，锁片无法组装到位的检知构造。
- 混合型的接插件具有在未完全嵌合的状态下，无法固定到车体支架上的锁定构造。
- 混合型的接插件可以直接固定在车体的支架上。
- 可对应欧盟 RoHS 和 ELV 指令

HX SEALED SERIES for STANDARD

1.0mm (040)

Structure / 构造

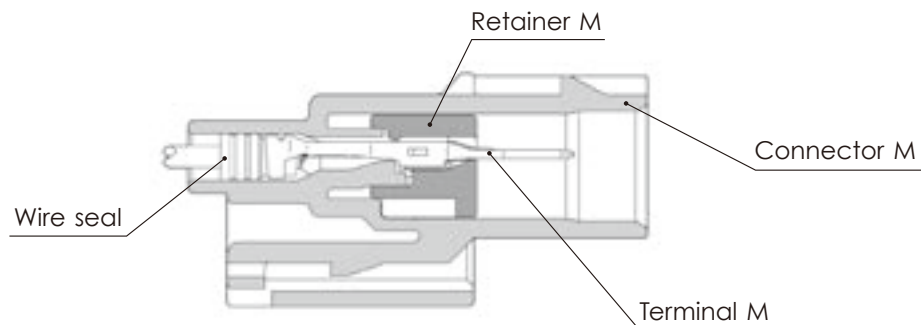

Connector M

Connector F

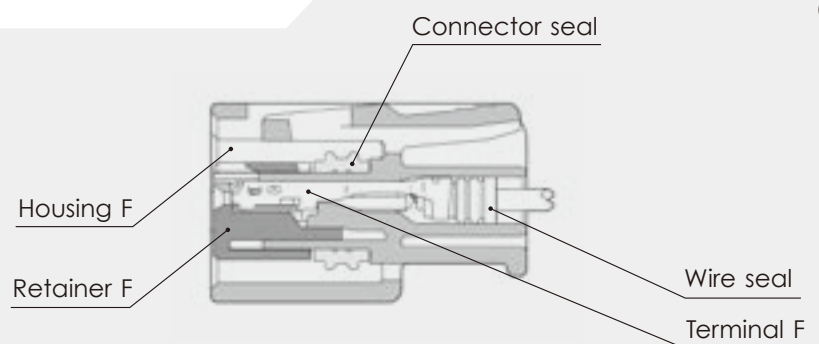

1.0mm (040)

Terminal (UNIT : mm)

端子(毫米)

(S)

Cable size (mm²) 适用电线大小	0.3~0.5
Cable overall diameter(mm) 带绝缘层外径	1.4~2.0
Material 材质	Brass 黄铜
Surface treatment 表面处理	Tin-plated 镀锡

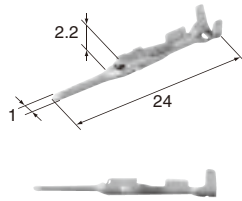
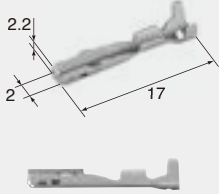
**M (8100-3177)**

Cable size (mm²) 适用电线大小	0.3~0.5
Cable overall diameter(mm) 带绝缘层外径	1.4~2.0
Material 材质	Heat-resistant copper alloy
Surface treatment 表面处理	Tin-plated 镀锡

F (8100-3067)**(M)**

Cable size (mm²) 适用电线大小	0.75~1.25
Cable overall diameter(mm) 带绝缘层外径	1.8~2.2
Material 材质	Heat-resistant copper alloy
Surface treatment 表面处理	Tin-plated 镀锡

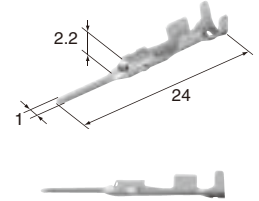
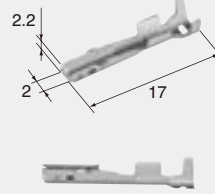
**M (8100-3178)**

Cable size (mm²) 适用电线大小	0.75~1.25
Cable overall diameter(mm) 带绝缘层外径	1.8~2.2
Material 材质	Heat-resistant copper alloy
Surface treatment 表面处理	Tin-plated 镀锡

F (8100-3068)**1.0mm (040)****Wire seals (UNIT : mm)**

电线密封栓(毫米)

The wire seals are common to M and F.

电线密封栓为公端、母端共用。

(SS)

Cable size (mm²) 适用电线大小	(AVSS/0.3) (AVSSX/0.3) (AVSSH/0.3) (CHFUS/0.35) (CHFS/0.5)
Cable overall diameter(mm) 带绝缘层外径	1.1~1.6
Material 材质	Silicon 硅
Color 颜色	Orange 橙

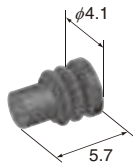
(7165-1075)**(S)**

Cable size (mm²) 适用电线大小	(AVS/0.3) (AVSS/0.5) (AVSSX/0.5) (AVSSH/0.5) (CHFS/0.75)
Cable overall diameter(mm) 带绝缘层外径	1.6~1.9
Material 材质	Silicon 硅
Color 颜色	Light Green 淡绿

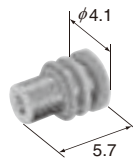
(7165-0621)**(M)**

Cable size (mm²) 适用电线大小	(AVS/0.5) (AVS/0.85) (AVSS/0.75~1.25) (AVSSX/0.75~1.25) (AVSSH/0.75~1.25) (AVX/0.5) (AVX/0.75) (CHFS/1.0)
Cable overall diameter(mm) 带绝缘层外径	1.8~2.2
Material 材质	Silicon 硅
Color 颜色	Violet 紫

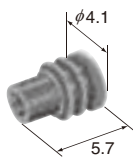
(7165-0622)

1.0mm (040)

Dummy plugs (UNIT : mm)

盲塞 (毫米)

- Dummy plugs are common to M and F.
- Dummy plugs are used to blind unused terminal holes.
- 盲塞为公端、母端共用。
- 盲塞用于堵塞不使用的端子孔。

E-04

1.0mm (040)

Housing (UNIT : mm)

接插件护套 (毫米)

Ref: Terminal part No. E-02
端子参照页

Ref: wire seal No. E-03
电线密封栓参照页

Ref: Dummy plug No. E-04
盲塞参照页

Material PBT
材质

(7165-0432)



Material 材质	NBR
Color 颜色	Black 黑

1way

Color 颜色	Black 黑
-------------	------------

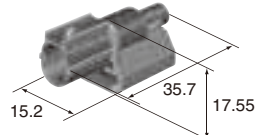

M (6188-0657)

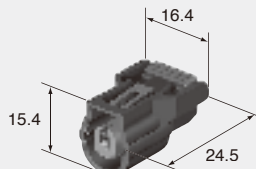

F (6189-0940)

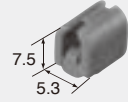

Retainer No. (6918-1979)

Color 颜色	Black 黑
-------------	------------

2way

Color 颜色	Black 黑
-------------	------------

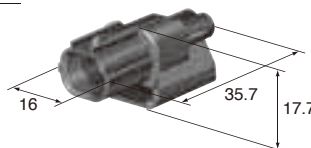

M (6188-0589)

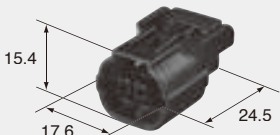

F (6189-0890)

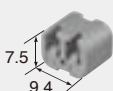

Retainer No. (6918-1835)

Color 颜色	Black 黑
-------------	------------

2way (Rib difference) (Rib差异)

Color 颜色	Dark Gray 深灰
-------------	-----------------

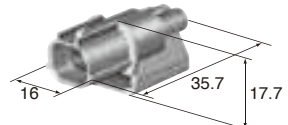

M (6188-0590)

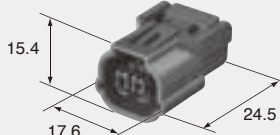

F (6189-0891)

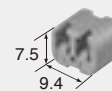

Retainer No. (6918-1835)

Color 颜色	Dark Gray 深灰
-------------	-----------------

3way

Color 颜色 Black 黑

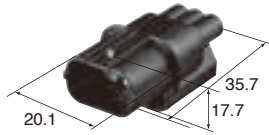

M (6188-4739)

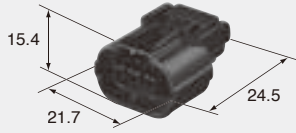

Color 颜色 Black 黑

F (6189-0887)

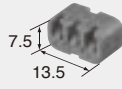

Retainer No. (6918-1833)

6way

Color 颜色 Black 黑

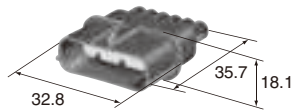

M (6188-0658)

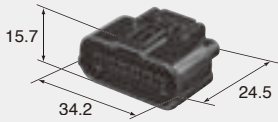

Color 颜色 Black 黑

F (6189-1012)

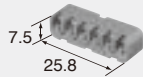

Retainer No. (6918-2056)

3way (Rib difference) (Rib差异)

F (6189-0968)

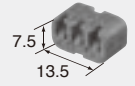
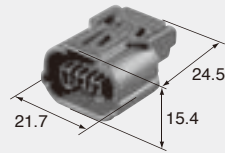

Retainer No. (6918-1833)

Color 颜色 Black 黑

5way

F (6189-1081)

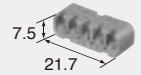
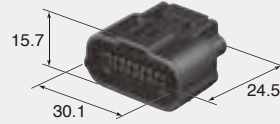

Retainer No. (6918-2128)

Color 颜色 Black 黑

7way

F (6189-0855)

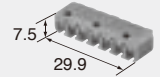
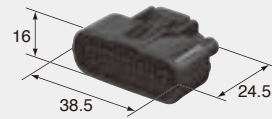

Retainer No. (6918-1762)

Color 颜色 Black 黑

HX SEALED SERIES for 23way and 33way

1.0mm (040)

Structure / 构造

E-06

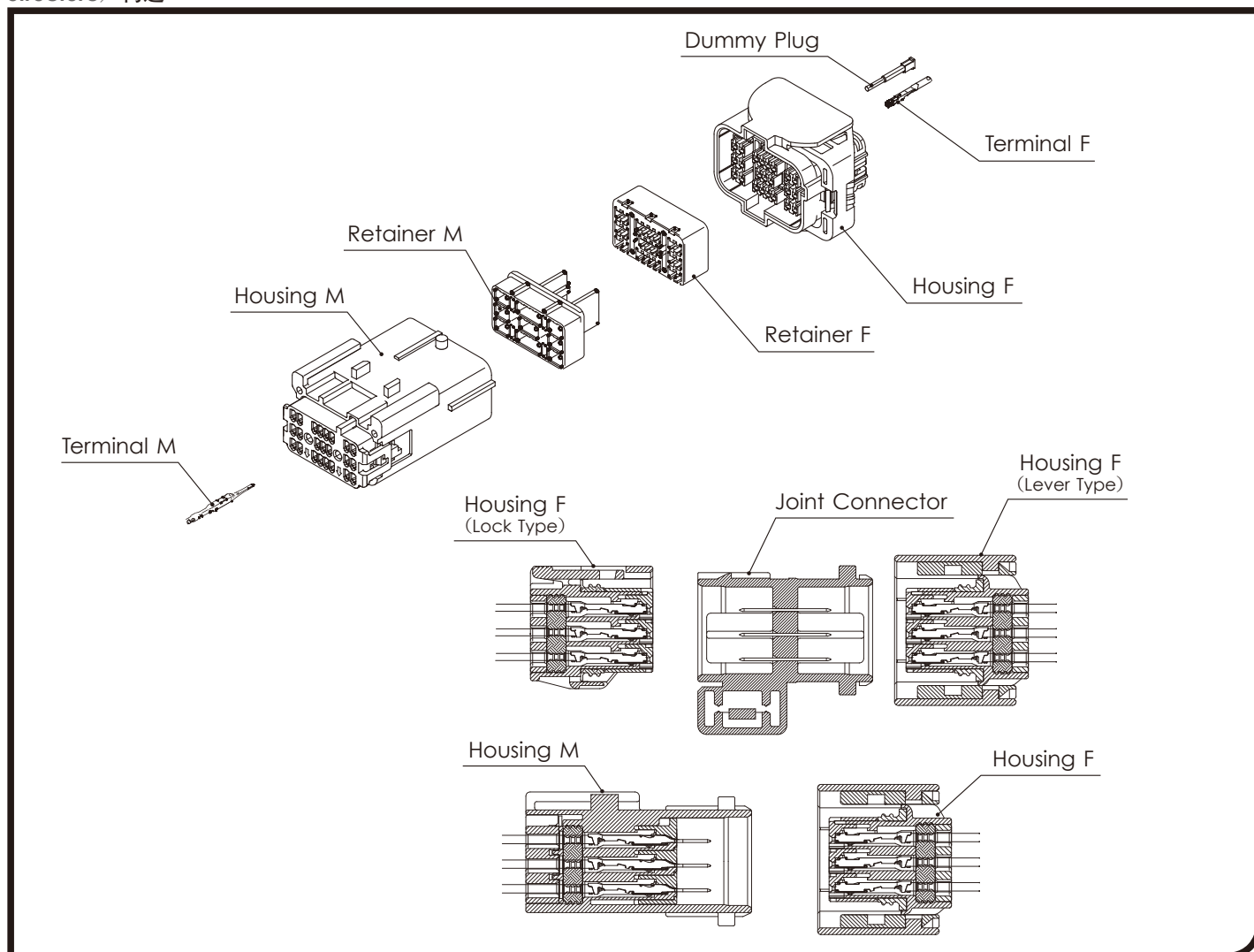

1.0mm (040)

Terminal (UNIT : mm)

端子(毫米)

(S)

Cable size (mm²) 适用电线大小	0.3~0.5
Material 材质	Brass 黄铜
Surface treatment 表面处理	Tin-plated 镀锡

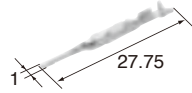
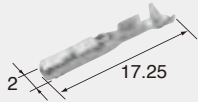
**M (8100-3508)****F (8100-3082)**

Cable size (mm²) 适用电线大小	0.3~0.5
Material 材质	Heat-resistant copper alloy
Surface treatment 表面处理	Tin-plated 镀锡

(M)

Cable size (mm²) 适用电线大小	0.75~1.25
Material 材质	Heat-resistant copper alloy
Surface treatment 表面处理	Tin-plated 镀锡

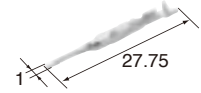
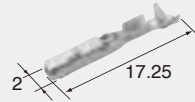
**M (8100-3507)****F (8100-3083)**

Cable size (mm²) 适用电线大小	0.75~1.25
Material 材质	Heat-resistant copper alloy
Surface treatment 表面处理	Tin-plated 镀锡

1.0mm (040)**Dummy plugs (UNIT : mm)**

盲塞 (毫米)

- Dummy plugs are common to M and F.
- Dummy plugs are used to blind unused terminal holes.
- 盲塞为公端、母端共用。
- 盲塞用于堵塞不使用的端子孔。

1.0mm (040)**Housing (UNIT : mm)**

接插件护套 (毫米)

Ref: Terminal part No. 端子参照页	E-07
Ref: Dummy plug No. 盲塞参照页	E-07
Material 材质	PBT

(6914-0050)

Material 材质	PP
Color 颜色	Brown 棕

**23way**

Color 颜色	Black 黑
--------------------	------------

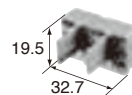

Retainer No. (6918-2131)

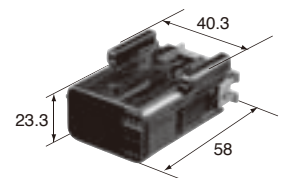
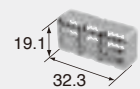
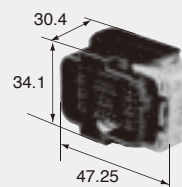
**M (6188-0660)****F (6189-1082)**

Retainer No. (6918-2132)

Color 颜色	Black 黑
--------------------	------------

23way

Joint Connector

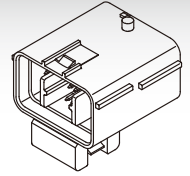

Coupling circuit is connected with busbers as shown gray hatched cavities.

M (6188-4787)

Color: Black
颜色: 黑

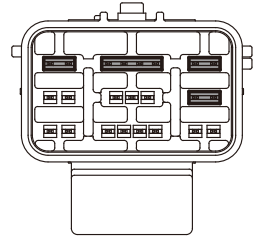
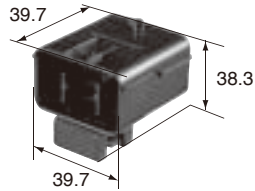

M (6188-4789)

Color: Dark Gray
颜色: 深灰

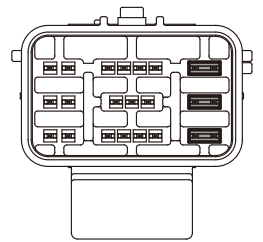
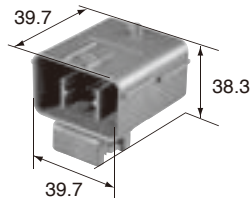

M (5010-8627)

Color: Dark Blue
颜色: 藏青

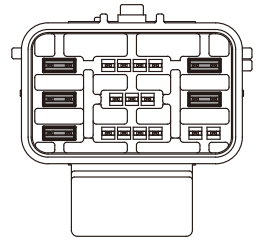
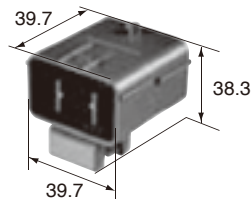

M (5011-1590)

Color: Brown
颜色: 棕

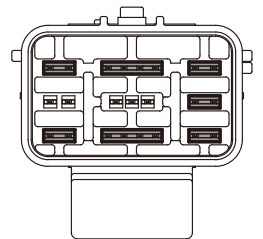
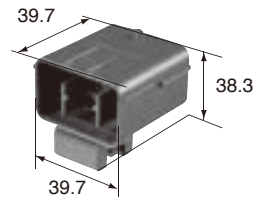

M (5011-6687)

Color: Blue
颜色: 蓝

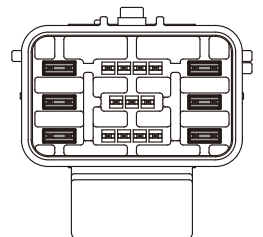
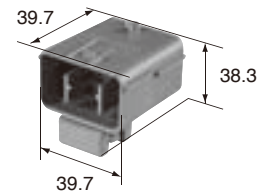

F (6189-1082)

Lever

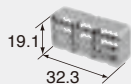
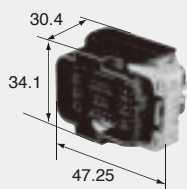

Retainer No. (6918-2132)

Color: Black
颜色: 黑

Lock

F (6189-6914)

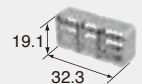
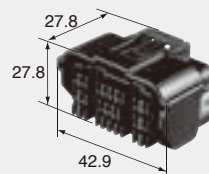

Retainer No. (6918-2132)

Color: Black
颜色: 黑

33way

Color 颜色 Black 黑

Retainer No. (6918-2103)

M (6188-0697) **F (6189-1050)**

Retainer No. (6918-2104)

Color 颜色 Black 黑

33way (Rib difference) (Rib差异)

Color 颜色 Dark Gray 深灰

Retainer No. (6918-2103)

M (6188-0698) **F (6189-1051)**

Retainer No. (6918-2104)

Color 颜色 Dark Gray 深灰

Bracket Holder

(6920-0886)

Color 颜色 Black 黑

Bracket Holder

(6920-0861)

Color 颜色 Black 黑

Bracket Holder

(6920-2376)

Color 颜色 Dark Blue 藏青

Bracket Holder

(6920-2377)

Color 颜色 Black 黑

Bracket Holder

(6920-0884)

Color 颜色 Black 黑

Bracket Holder

(6920-2466)

Color 颜色 Black 黑

HX SEALED SERIES 22way Joint Connector

HYBRID 0.64mm,1.0mm (025, 040)

Structure / 构造

E-10

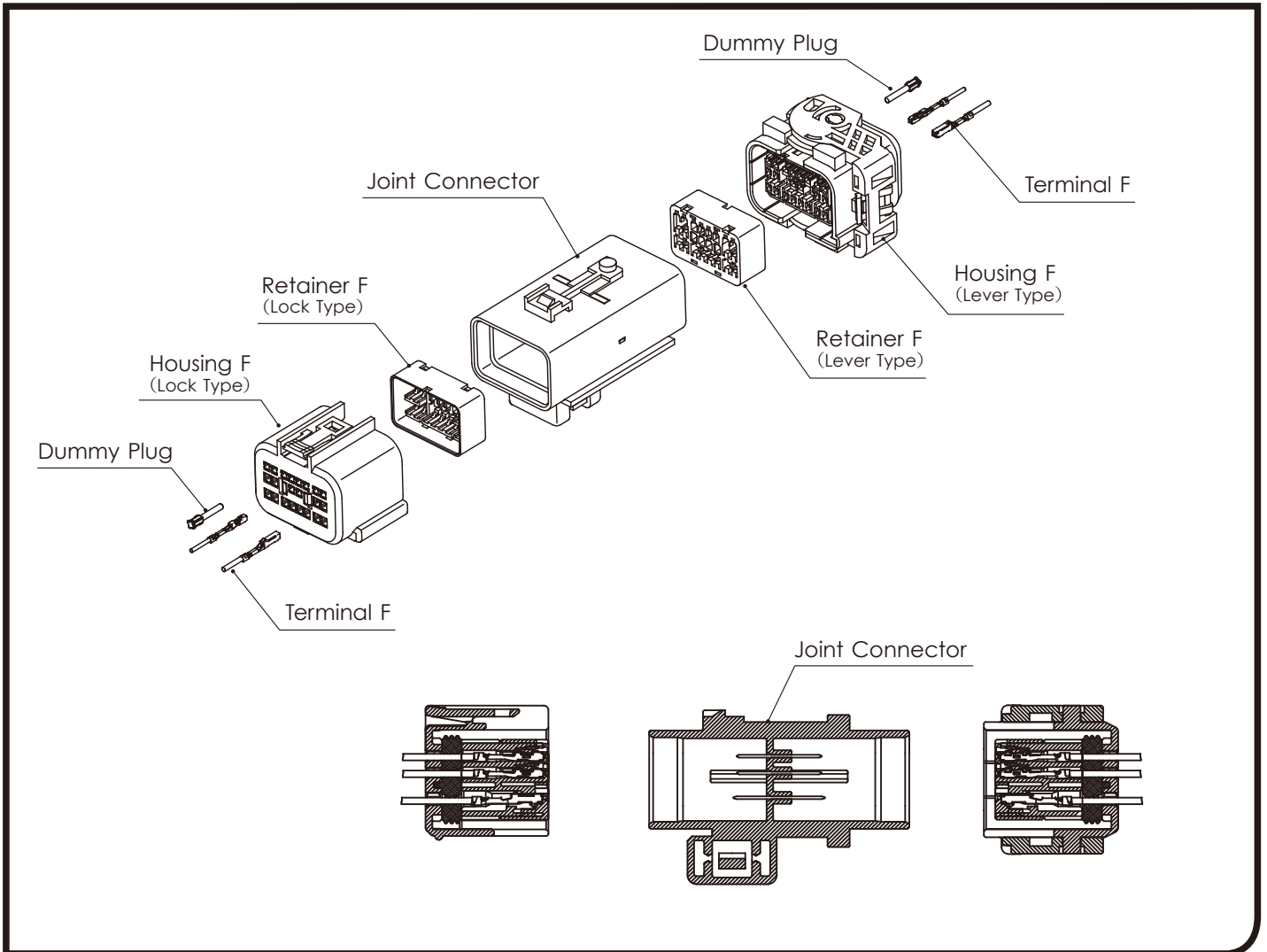

0.64mm (025)

Terminal (UNIT: mm)

端子(毫米)

(SS)

F (8240-0408)

Cable size (mm ²) 适用电线大小	AVSSH0.22
Material 材质	Heat-resistant copper alloy
Surface treatment 表面处理	Tin-plated 镀锡

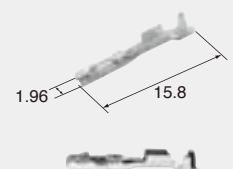

(S)**F (8240-0409)**

Cable size (mm²) 适用电线大小	AVSSH0.3~0.5
Material 材质	Heat-resistant copper alloy
Surface treatment 表面处理	Tin-plated 镀锡

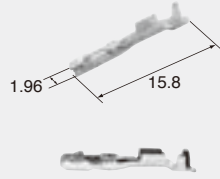
**(M)****F (8240-0410)**

Cable size (mm²) 适用电线大小	AVSSH0.75
Material 材质	Heat-resistant copper alloy
Surface treatment 表面处理	Tin-plated 镀锡

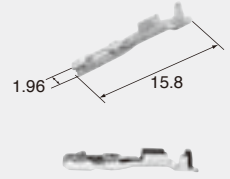
**1.0mm (040)****Terminal (UNIT : mm)**

端子(毫米)

(S)**F (8240-0411)**

Cable size (mm²) 适用电线大小	AVSSH0.3 ~AVSSH0.5
Material 材质	Heat-resistant copper alloy
Surface treatment 表面处理	Tin-plated 镀锡

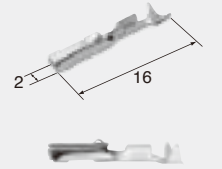
**(M)****F (8240-0412)**

Cable size (mm²) 适用电线大小	AVSSH0.75 ~AVSSH1.25
Material 材质	Heat-resistant copper alloy
Surface treatment 表面处理	Tin-plated 镀锡

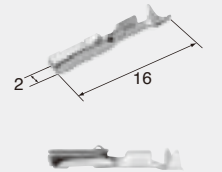
**0.64mm, 1.0mm (025, 040)****Dummy plugs (UNIT : mm)**

盲塞(毫米)

- Dummy plugs are common to M and F.
- Dummy plugs are used to blind unused terminal holes.
- 盲塞为公端、母端共用。
- 盲塞用于堵塞不使用的端子孔。

(6914-0127)

Material 材质	PBT
Color 颜色	Blue 蓝



0.64mm, 1.0mm
(025,040)

Housing (UNIT: mm)

接插件护套(毫米)

Ref: Terminal part No. 端子参照页	[0.64mm] [1.0mm]	E-10 E-11
Ref: Dummy plug No. 盲塞参照页	[0.64mm] [1.0mm]	E-11 E-11
Material 材质	PBT	

22way (10+12)

Joint Connector

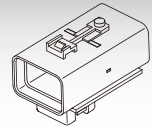

Coupling circuit is connected with busbers as shown gray hatched cavities.

M (5011-6818)

Color
颜色

Brown
棕

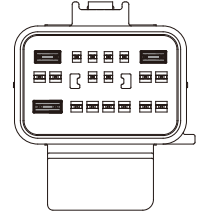
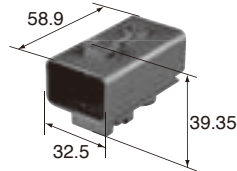

M (5011-7740)

Color
颜色

Black
黑

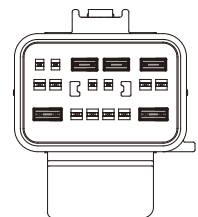
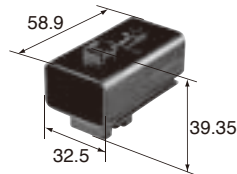

M (5011-7860)

Color
颜色

Dark Gray
深灰

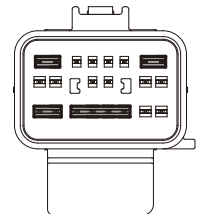
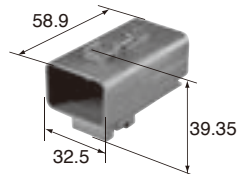

F (6189-7264) Lever

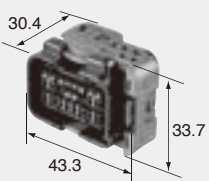

Color
颜色

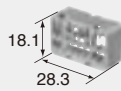

Retainer No. (6918-3166)

Black
黑

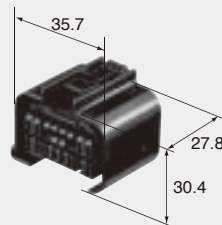

Lock F (6189-7263)

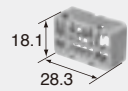

Retainer No. (6918-3166)

Color
颜色

Black
黑

HX SEALED SERIES for STANDARD

1.5mm (060)

Structure / 构造

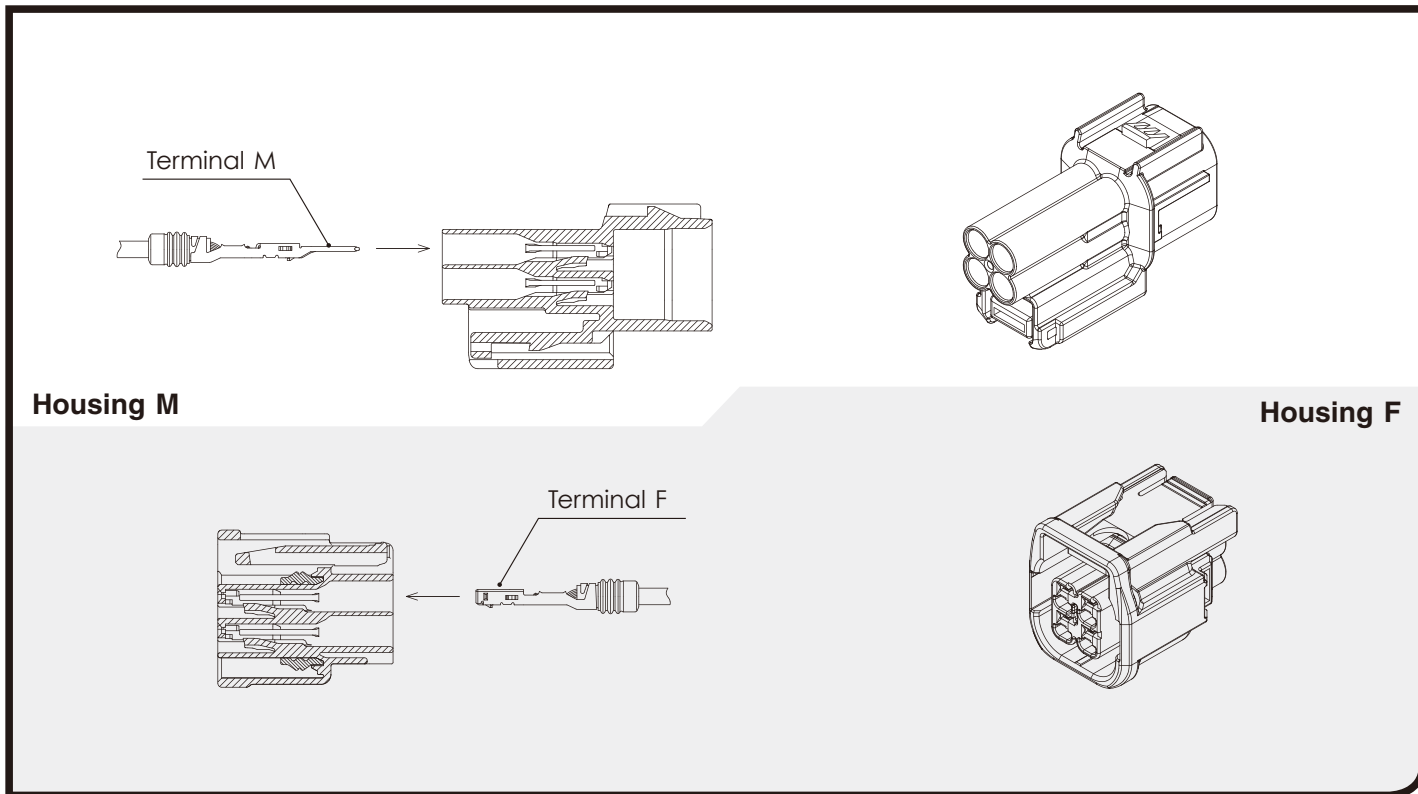

E-13

HX SEALED SERIES

1.5mm (060)

Terminal (UNIT : mm)

端子(毫米)

(SS)

Cable size (mm ²) 适用电线大小	0.13~0.22
---	-----------

Material 材质	Brass 黄铜
----------------	-------------

Surface treatment 表面处理	Tin-plated 镀锡
---------------------------	------------------

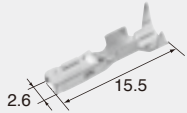
**M (8230-5306)****F (8240-0489)**

Cable size (mm ²) 适用电线大小	0.13~0.22
---	-----------

Material 材质	Heat-resistant copper alloy
----------------	--------------------------------

Surface treatment 表面处理	Tin-plated 镀锡
---------------------------	------------------

(S)

Cable size (mm ²) 适用电线大小	0.3~0.5
---	---------

Material 材质	Brass 黄铜
----------------	-------------

Surface treatment 表面处理	Tin-plated 镀锡
---------------------------	------------------

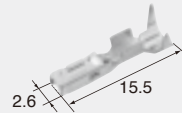
**M (8230-5307)****F (8240-0490)**

Cable size (mm ²) 适用电线大小	0.3~0.5
---	---------

Material 材质	Heat-resistant copper alloy
----------------	--------------------------------

Surface treatment 表面处理	Tin-plated 镀锡
---------------------------	------------------

(M)

Cable size (mm ²) 适用电线大小	0.75~1.25
---	-----------

Material 材质	Brass 黄铜
----------------	-------------

Surface treatment 表面处理	Tin-plated 镀锡
---------------------------	------------------

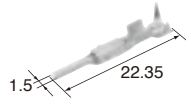
**M (8230-5308)****F (8240-0491)**

Cable size (mm ²) 适用电线大小	0.75~1.25
---	-----------

Material 材质	Heat-resistant copper alloy
----------------	--------------------------------

Surface treatment 表面处理	Tin-plated 镀锡
---------------------------	------------------

(L)

Cable size (mm ²) 适用电线大小	2.0
---	-----

Material 材质	Brass 黄铜
----------------	-------------

Surface treatment 表面处理	Tin-plated 镀锡
---------------------------	------------------

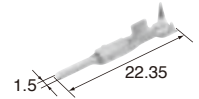
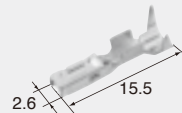
**M (8230-5309)****F (8240-0492)**

Cable size (mm ²) 适用电线大小	2.0
---	-----

Material 材质	Heat-resistant copper alloy
----------------	--------------------------------

Surface treatment 表面处理	Tin-plated 镀锡
---------------------------	------------------

1.5mm (060)**Wire seals (UNIT : mm)**

电线密封栓(毫米)

电线密封栓为公端、母端共用。

(SS)**(7165-1562)**

Cable overall diameter (mm) 带绝缘层外径	0.85~1.2
---------------------------------------	----------

Material 材质	Silicon 硅
----------------	--------------

Color 颜色	Violet 紫
-------------	-------------

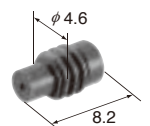

(S)**(7165-1563)**Cable overall diameter (mm)
带绝缘层外径 1.05~1.5

Material 材质	Silicon 硅
Color 颜色	Sky Blue 天蓝

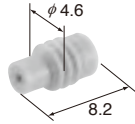
**(M)****(7165-1564)**Cable overall diameter (mm)
带绝缘层外径 1.35~1.9

Material 材质	Silicon 硅
Color 颜色	Light Green 淡绿

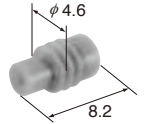
**(L)****(7165-1565)**Cable overall diameter (mm)
带绝缘层外径 1.75~2.4

Material 材质	Silicon 硅
Color 颜色	Blue 蓝

**(LL)****(7165-1566)**Cable overall diameter (mm)
带绝缘层外径 2.4~3

Material 材质	Silicon 硅
Color 颜色	Dark Yellow 深黄色

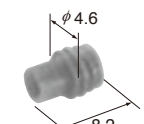

1.5mm (060)

Dummy plugs (UNIT : mm)

盲塞 (毫米)

Ref; 1.5mm Dummy plug detail
1.5mm盲塞参照页

(7165-0193) J-07

- Dummy plugs are common to M and F.
- Dummy plugs are used to blind unused terminal holes.
- 盲塞为公端、母端共用。
- 盲塞用于堵塞不使用的端子孔。

1.5mm (060)

Housing (UNIT : mm)

接插件护套 (毫米)

Ref: Terminal part No. E-14
端子参照页

Ref: wire seal No. E-14
电线密封栓参照页

Ref: Dummy plug No. J-07
盲塞参照页

Material 材质	PBT
-----------------------	-----

2way

Color 颜色	Black 黑
--------------------	------------

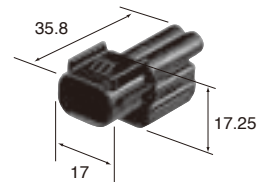
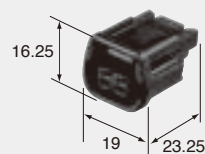
**M (6181-6851)****F (6189-7408)**

Color 颜色	Black 黑
--------------------	------------

E-15

HX SEALED SERIES

3way

F (6189-7494)



Color: Black
颜色: 黑

4way

Color: Black
颜色: 黑

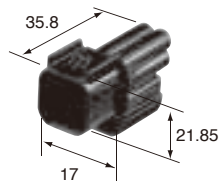

M (6181-6783)

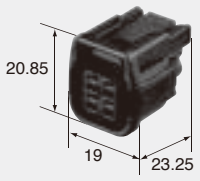

Color: Black
颜色: 黑

F (6189-7409)

8way

Color: Black
颜色: 黑

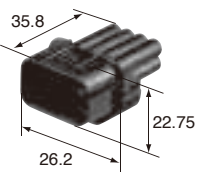

M (6181-6850)

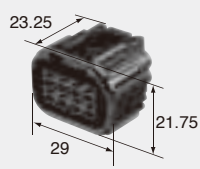

Color: Black
颜色: 黑

F (6189-7423)

12way

Color: Black
颜色: 黑

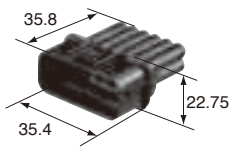

M (6181-6784)

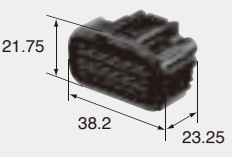

Color: Black
颜色: 黑

F (6189-7410)

HX SEALED SERIES for STANDARD

2.3mm (090)

Structure / 构造

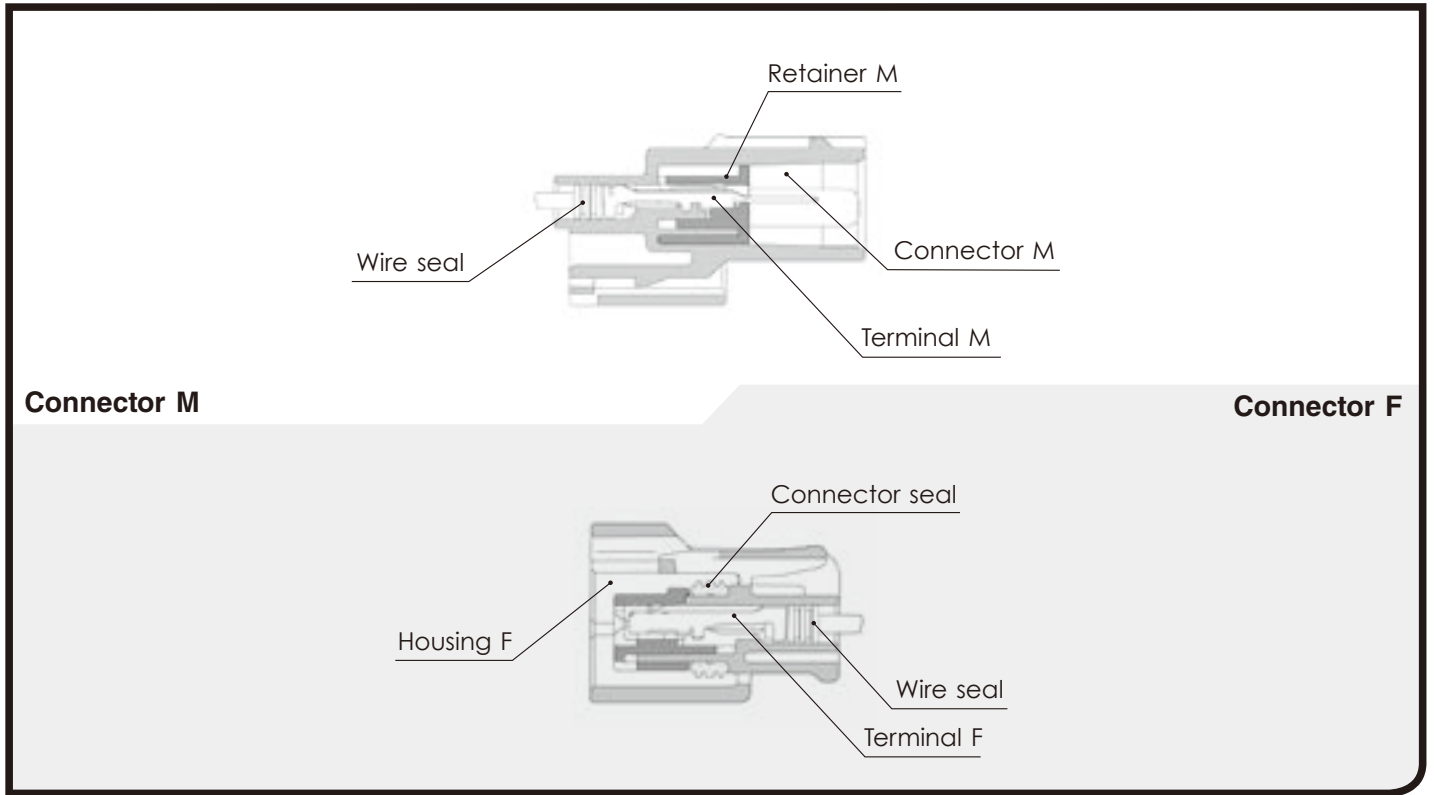

E-17

HX SEALED SERIES

2.3mm (090)

Terminal (UNIT : mm)

端子 (毫米)

Ref; 2.3mm Terminal detail
2.3mm端子参照页

S	M (8230-4472)	L-02
M	M (8230-4562)	L-02
L	M (8230-4552)	L-02

(S)		F (8240-4862)
Cable size (mm²) 适用电线大小	0.3~0.5	
Cable overall diameter (mm) 带绝缘层外径	1.4~2.4	
Material 材质	Heat-resistant copper alloy	
Surface treatment 表面处理	Tin-plated 镀锡	

(M)**F (8240-4992)**

Cable size (mm²) 适用电线大小	0.75~0.85
Cable overall diameter(mm) 带绝缘层外径	1.8~2.6
Material 材质	Heat-resistant copper alloy
Surface treatment 表面处理	Tin-plated 镀锡

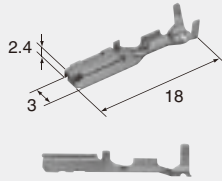
**(L)****F (8240-4952)**

Cable size (mm²) 适用电线大小	1.25~2.0
Cable overall diameter(mm) 带绝缘层外径	2.1~2.9
Material 材质	Heat-resistant copper alloy
Surface treatment 表面处理	Tin-plated 镀锡

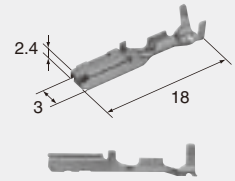
**2.3mm (090)****Wire seals (UNIT : mm)**

电线密封栓 (毫米)

The wire seals are common to M and F.

电线密封栓为公端、母端共用。

(SS)**(7165-0385)**

Cable size (mm²) 适用电线大小	(AVSS/0.3~0.5) (AVSSX/0.5)
Cable overall diameter(mm) 带绝缘层外径	1.2~1.7
Material 材质	Silicon 硅
Color 颜色	Gray 灰

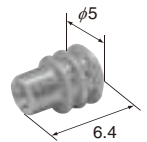
**(S)****(7165-0194)**

Cable size (mm²) 适用电线大小	(AV/0.5) (AVX/AEX/0.5~0.75) (AVS/0.3~0.85) (AVSS/0.85~1.25) (AVSSX/0.75~1.25)
Cable overall diameter(mm) 带绝缘层外径	1.7~2.4
Material 材质	Silicon 硅
Color 颜色	Green 绿

**(M)****(7165-0198)**

Cable size (mm²) 适用电线大小	(AV/0.5~1.25) (AVX/AEX/0.75~1.25) (AVS/0.85~1.25) (AVSS/1.25~2.0) (AVSSX/1.25~2.0)
Cable overall diameter(mm) 带绝缘层外径	2.1~2.9
Material 材质	Silicon 硅
Color 颜色	Yellow 黄

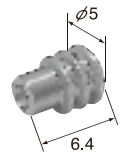
**2.3mm (090)****Dummy plugs (UNIT : mm)**

盲塞 (毫米)

Ref: 2.3mm Dummy plug detail

2.3mm盲塞参照页

(7165-0193) J-07

- Dummy plugs are common to M and F.
- Dummy plugs are used to blind unused terminal holes.
- 盲塞为公端、母端共用。
- 盲塞用于堵塞不使用的端子孔。

2.3mm (090)

Housing (UNIT : mm)

接插件护套(毫米)

Ref: Terminal part No. 端子参照页	E-17
Ref: wire seal No. 电线密封栓参照页	E-18
Ref: Dummy plug No. 盲塞参照页	J-07
Material 材质	PBT

1way

Color Black
颜色 黑

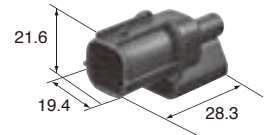
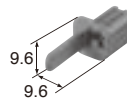

Retainer No. (6918-2665)

M (6181-0803)

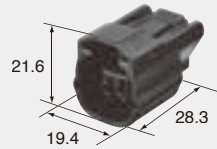

F (6189-0591)

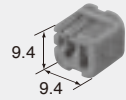

Retainer No. (6918-1370)

Color Black
颜色 黑

2way

F (6189-0552)

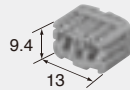
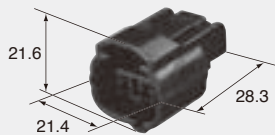

Note)

Retainer No. (6918-1260)

Color Black
颜色 黑

2way

(Rib difference) (Rib差异)

F (6189-0593)

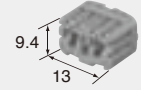
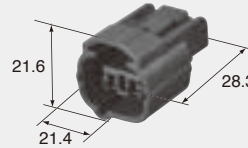

Note)

Retainer No. (6918-1260)

Color Brown
颜色 棕

3way

F (6189-0596)

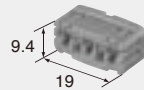
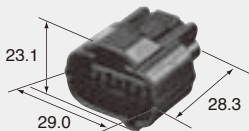

Note)

Retainer No. (6918-1371)

Color Black
颜色 黑

4way

F (6189-0617)

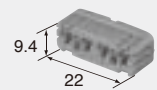
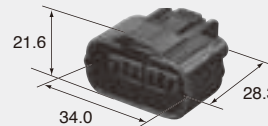

Note)

Retainer No. (6918-1469)

Color Black
颜色 黑

HX SEALED SERIES

for HYBRID

4.8mm (187)

Terminal (UNIT: mm)

端子(毫米)

Ref: 4.8mm Terminal detail
4.8mm端子参照页

S **M(8100-0463)** B-19

M **M(8100-0464)** B-19

L **M(8100-0465)** B-19 **F(8100-0468)** B-19

4.8mm (187)

Wire seals (UNIT: mm)

电线密封栓(毫米)

The wire seals are common to M and F.

电线密封栓为公端、母端共用。

(S)

Cable size (mm²) 0.3~0.5

Cable overall diameter (mm) 1.4~2.4

Material Heat-resistant copper alloy

Surface treatment Tin-plated

表面处理 镀锡

F(8100-0661)

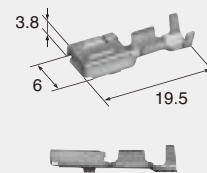

(M)

Cable size (mm²) 0.5~1.25

Cable overall diameter (mm) 1.6~2.6

Material Heat-resistant copper alloy

Surface treatment Tin-plated

表面处理 镀锡

F(8100-0660)

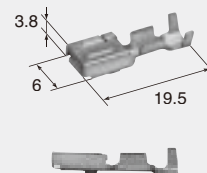

(S)

for 2.3mm, 4.8mm 10way

(7165-0172)

Cable size (mm²) (AVS/0.3) (AVSS/0.3~0.85)

Cable overall diameter (mm) (AVSSX/0.5~0.75)

Material NBR

Color Brown

颜色 棕

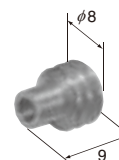

(M)

for 2.3mm, 4.8mm 10way

(7165-0130)

Cable size (mm²) (AV/0.5~1.25) (AVX/0.5~1.25) (AVS/0.3~1.25)

Cable overall diameter (mm) (AVSS/0.85~2.0) (AVSSX/0.75~2.0)

Material NBR

Color Gray

颜色 灰



(L)

for 2.3mm, 4.8mm 10way

(7165-0131)

Cable size (mm²) (AV/2.0~3.0) (AVX/2.0~3.0)
 适用电线大小 (AVS/2.0~3.0)

Cable overall diameter(mm)
 带绝缘层外径 3.0~4.1

Material
 材质 NBR

Color
 颜色 Black
 黑

**(M)**

for 1.0mm, 4.8mm 13way

(7165-0147)

Cable size (mm²) (AVS/0.3~1.25)

Cable overall diameter(mm)
 带绝缘层外径 1.8~2.9

Material
 材质 Silicon
 硅

Color
 颜色 Dark Green
 墨绿

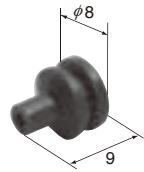
**(L)**

for 1.0mm, 4.8mm 13way

(7165-0148)

Cable size (mm²) (AVS/2.0~3.0)

Cable overall diameter(mm)
 带绝缘层外径 3.0~4.1

Material
 材质 Silicon
 硅

Color
 颜色 Dark Blue
 藏青

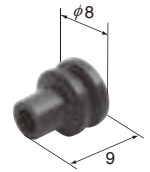

1.0mm, 4.8mm (040, 187)

Housing (UNIT : mm)

接插件护套(毫米)

Ref: Terminal part No. [1.0mm] E-02
 端子参照页 [4.8mm] E-20

Ref: wire seal No. [1.0mm] E-03
 电线密封栓参照页 [4.8mm] E-21

Ref: Dummy plug No. [1.0mm] E-04
 盲塞参照页 [4.8mm] B-21

Material
 材质 PBT

No. of way/ () corresponds to 1.0mm, 4.8mm, in order from left to right.
 极数 / () 内显示 : 从左向右为1.0mm 极数、4.8mm 极数

13way (12+1)

Color
 颜色 Black
 黑

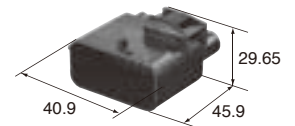
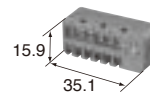

Retainer No. (6181-6465)

M (6181-6464)

F (6189-6863)

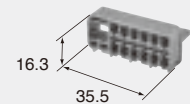
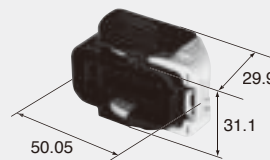

Retainer No. (6185-4596)

Color
 颜色 Black
 黑

1.5mm, 4.8mm (060, 187)

Housing (UNIT : mm)

接插件护套(毫米)

Ref: Terminal part No. [1.5mm] E-14
 端子参照页 [4.8mm] E-20

Ref: wire seal No. [1.5mm] E-15
 电线密封栓参照页 [4.8mm] E-20

Ref: Dummy plug No. [1.5mm] J-07
 盲塞参照页 [4.8mm] B-21

Material
 材质 PBT

No. of way/ () corresponds to 1.5mm, 4.8mm, in order from left to right.
 极数 / () 内显示 : 从左向右为1.5mm 极数、4.8mm 极数

4way (2+2)

Color
 颜色 Black
 黑

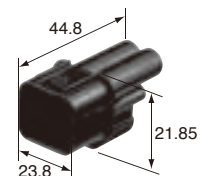

M (6181-6785)

F (6189-7411)

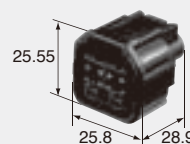

Color
 颜色 Black
 黑

5way (3+2)

Color Dark gray
颜色 深灰

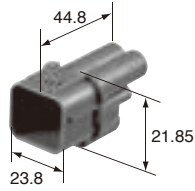

M (6181-6921)

F (6189-7567)

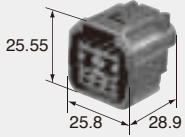

Color Dark gray
颜色 深灰

2.3mm, 4.8mm (090, 187)

Housing (UNIT : mm)

接插件护套(毫米)

Ref: Terminal part No. 端子参照页	[2.3mm] [4.8mm]	E-17 E-20
Ref: wire seal No. 电线密封栓参照页	[2.3mm] [4.8mm]	E-18 E-21
Ref: Dummy plug No. 盲塞参照页	[2.3mm] [4.8mm]	J-07 B-21

Material PBT
材质

No. of way/ () corresponds to 2.3mm, 4.8mm, in order from left to right.
极数 / () 内显示: 从左向右为2.3mm 极数、4.8mm 极数

10way (8+2)

Color Dark gray
颜色 深灰

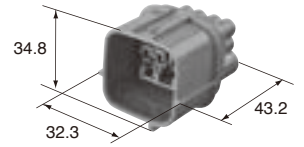
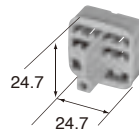

Retainer No. (6918-1263)

M (6181-0381)

F (6189-0555)

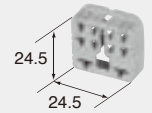
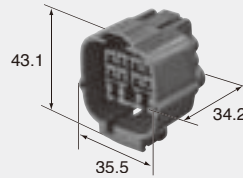

Retainer No. (6918-1267)

Color Dark gray
颜色 深灰