

SL SERIES

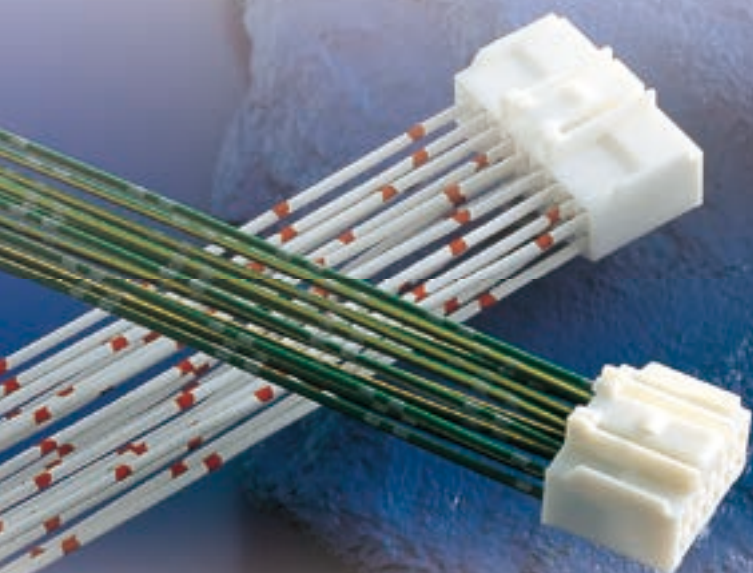

Features

The SL connector series is adopted a mechanism that detects terminal incomplete insertion by using a dedicated jig.

This series consists of 1.5mm, 2.3mm and 2.8mm types classified according to the terminal size, covering an extensive array of applications from signal circuits to low power circuits.

- These connectors can be directly secured to a bracket on the car body. In addition, an extra clip can be attached to the connector to secure it to the car body. (Note: Please contact our sales staff, if you have any questions regarding the dedicated jig.)
- RoHS/ELV Compliant

特点

SL 系列接插件采用了以专用治具检测端子半插入的构造。

按照端子尺寸划分为1.5mm·2.3mm·2.8mm 类型，从信号回路到电源回路，能广泛运用。

- 接插件可以直接固定在车体的支架上。还可以在接插件上安装用于固定到车体上的卡钉（卡子）。

注意：有关专用导通治具的详情请向敝公司销售负责人确认。

- 可对应欧盟 RoHS 和 ELV 指令

SL SERIES for STANDARD

1.5mm (060)

Structure / 构造

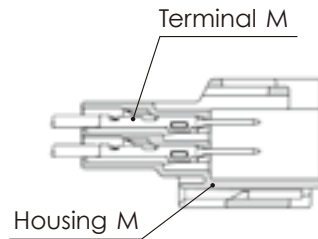
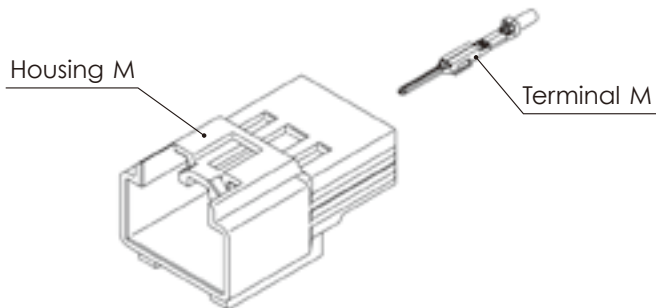

Connector M

Connector F

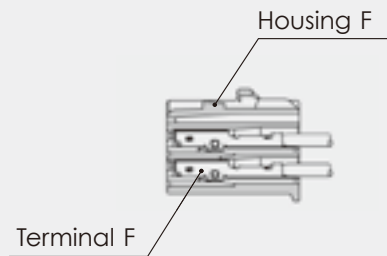
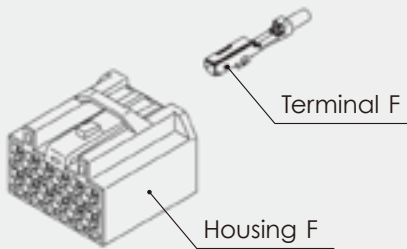

1.5mm (060)

Terminal (UNIT : mm)

端子(毫米)

Note) L size terminal can be used for 14 poled connectors with insertion cavity specified.
For details please contact our sales staff.

※ L 尺寸端子的可用接插件有限制。
务必向敝公司销售负责人问讯。

(S)

Cable size (mm²) 适用电线大小	0.3~0.5
Material 材质	Heat-resistant copper alloy
Surface treatment 表面处理	Tin-plated 镀锡

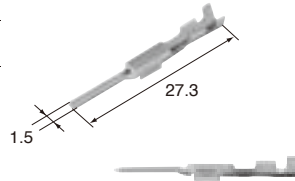
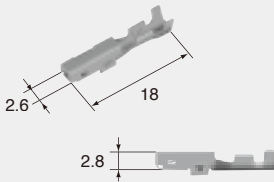
**M (8100-3382)**

Cable size (mm²) 适用电线大小	0.3~0.5
Material 材质	Heat-resistant copper alloy
Surface treatment 表面处理	Tin-plated 镀锡

F (8100-3391)**(S)**

Cable size (mm²) 适用电线大小	0.3~0.5
Material 材质	Heat-resistant copper alloy
Surface treatment 表面处理	Gold-plated 镀金

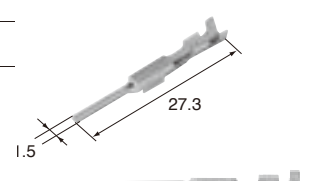
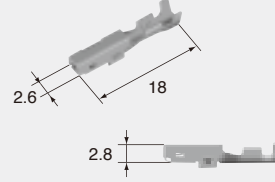
**M (8230-4883)**

Cable size (mm²) 适用电线大小	0.3~0.5
Material 材质	Heat-resistant copper alloy
Surface treatment 表面处理	Gold-plated 镀金

F (8240-0135)**(M)**

Cable size (mm²) 适用电线大小	0.75, 0.85~1.25
Material 材质	Heat-resistant copper alloy
Surface treatment 表面处理	Tin-plated 镀锡

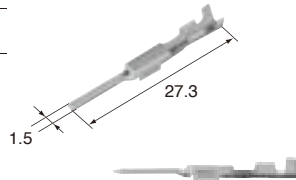
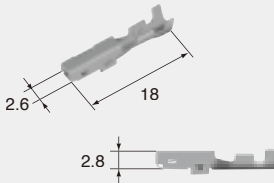
**M (8100-3383)**

Cable size (mm²) 适用电线大小	0.75, 0.85~1.25
Material 材质	Heat-resistant copper alloy
Surface treatment 表面处理	Tin-plated 镀锡

F (8100-3392)**(L)**

Cable size (mm²) 适用电线大小	2.0
Material 材质	Heat-resistant copper alloy
Surface treatment 表面处理	Tin-plated 镀锡

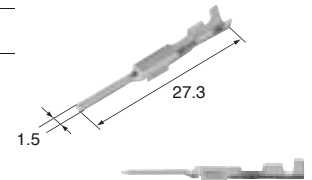
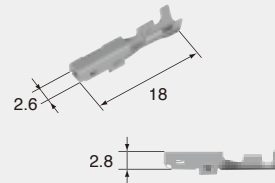
**M (8100-3384)**

Cable size (mm²) 适用电线大小	2.0
Material 材质	Heat-resistant copper alloy
Surface treatment 表面处理	Tin-plated 镀锡

F (8100-3393)**1.5mm (060)****Housing (UNIT : mm)**

接插件护套(毫米)

Ref: Terminal part No.
端子参照页

I-02

Material
材质

PBT

Note) Connector can be used together with 2mm² wire are 14 poled connectors.
For details of each product, please contact our sales staff.

※ L 尺寸端子的可用接插件有限制。
务必向敝公司销售负责人问讯。

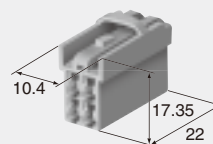
4way**F (6098-3456)**

Color
颜色

Natural
自然色

I-03

SL SERIES

12way

Color Natural
颜色 自然色

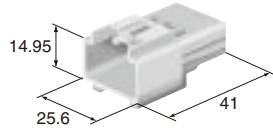

M (6098-3449)

F (6098-8482)

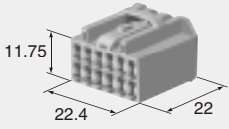

Color Natural
颜色 自然色

12way

F (6098-4876)

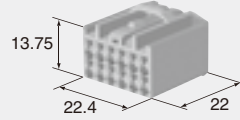

Color Natural
颜色 自然色

14way

F (6098-4877)

Note)

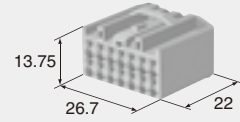

Color Natural
颜色 自然色

16way

F (6098-3453)

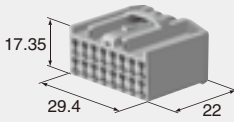

Color Natural
颜色 自然色

SL SERIES for STANDARD

2.3mm (090)

Structure / 构造

Connector F

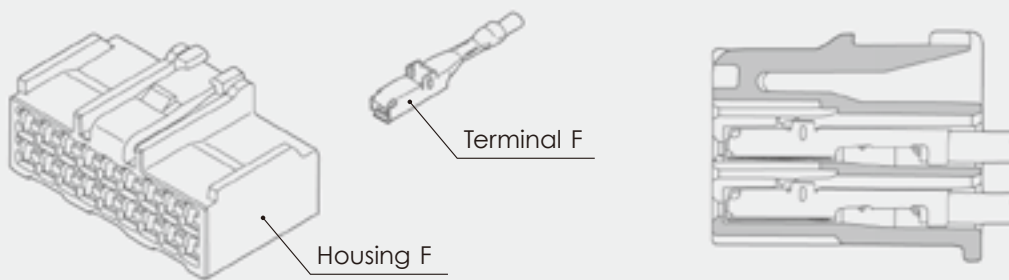

I-05

SL SERIES

2.3mm (090)

Terminal (UNIT : mm)

端子(毫米)

Ref; 2.3mm Terminal detail
2.3mm端子参照页

S	M (8230-4492)	A-10	F (8240-4882)	A-10
M	M (8230-4502)	A-10	F (8240-4892)	A-10
L	M (8230-4512)	A-10	F (8240-4942)	A-10

Regarding "Gold-plated Terminal", please refer "A-10".
镀金端子记载在A-10上

2.3mm (090)

Housing (UNIT : mm)

接插件护套(毫米)

Ref: Terminal part No. A-10
端子参照页

Material PBT
材质

2way

F (6240-5337)

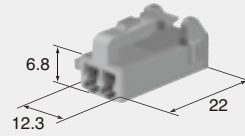

Color Natural
颜色 自然色

4way

F (6098-8478)

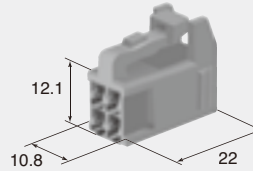

Color Natural
颜色 自然色

6way

F (6240-5339)

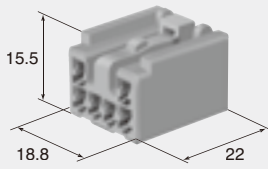

Color Natural
颜色 自然色

6way

Color Natural
颜色 自然色
Note With body fastening clamp
备注 带防转卡钉

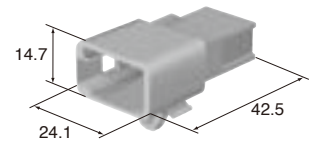
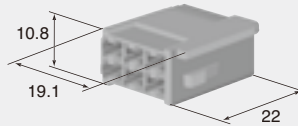

Plate thickness range for clamp :
t=0.6~2.0mm
Hole=7.2mm×12mm

M (6098-2679)

F (6098-2680)



Color Natural
颜色 自然色

12way

F (6098-1714)

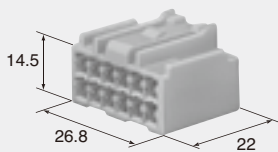

Color Natural
颜色 自然色

14way

F (6098-1747)

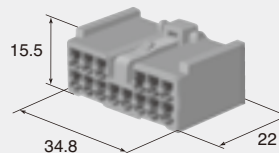

Color Natural
颜色 自然色

14way

F (6098-2101)

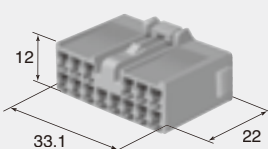

Color Natural
颜色 自然色

14way

F (6098-1774)

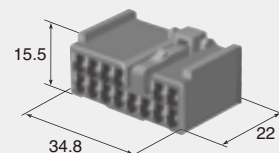

Color Black
颜色 黑

16way

Color Natural
颜色 自然色

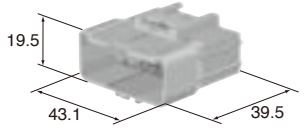

M (6098-1744) **F (6098-1746)**

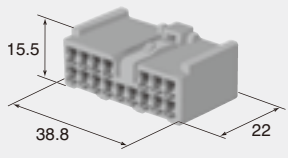

Color Natural
颜色 自然色

18way

F (6098-1627)

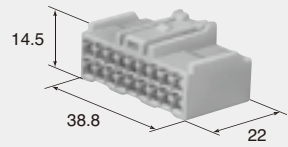

Color Natural
颜色 自然色

SL SERIES for STANDARD

2.8mm (110)

Structure / 构造



Connector M

Connector F

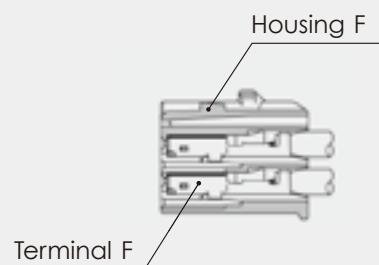
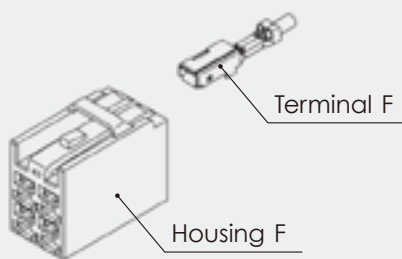

2.8mm (110)

Terminal (UNIT: mm)

端子(毫米)

(S)

Cable size (mm ²) 适用电线大小	0.3~0.5
Material 材质	Heat-resistant copper alloy
Surface treatment 表面处理	Tin-plated 镀锡

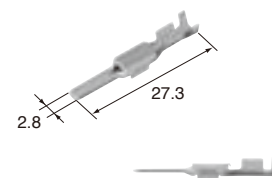

M (8100-3385)

F (8100-3394)

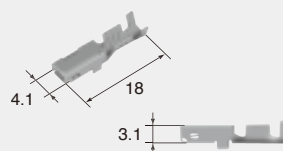

Cable size (mm ²) 适用电线大小	0.3~0.5
Material 材质	Heat-resistant copper alloy
Surface treatment 表面处理	Tin-plated 镀锡

(M)

Cable size (mm²) 适用电线大小	0.85~1.25
Material 材质	Heat-resistant copper alloy
Surface treatment 表面处理	Tin-plated 镀锡

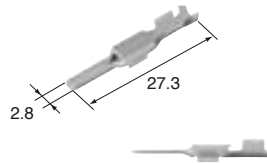
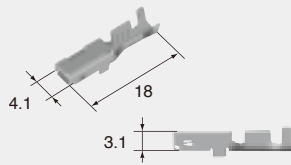
**M (8100-3386)****F (8100-3395)**

Cable size (mm²) 适用电线大小	0.85~1.25
Material 材质	Heat-resistant copper alloy
Surface treatment 表面处理	Tin-plated 镀锡

(L)

Cable size (mm²) 适用电线大小	2.0~3.0
Material 材质	Heat-resistant copper alloy
Surface treatment 表面处理	Tin-plated 镀锡

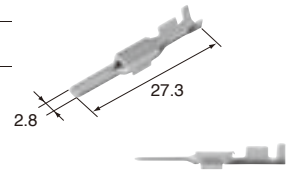
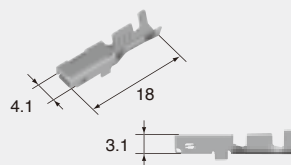
**M (8100-3387)****F (8100-3396)**

Cable size (mm²) 适用电线大小	2.0~3.0
Material 材质	Heat-resistant copper alloy
Surface treatment 表面处理	Tin-plated 镀锡

2.8mm (110)**Housing (UNIT : mm)**

接插件护套(毫米)

Ref. Terminal part No.
端子参照页

I-08

Material 材质	PBT
-----------------------	-----

4way

Color 颜色	Natural 自然色
Note 备注	With body fastening clamp 带防转卡钉

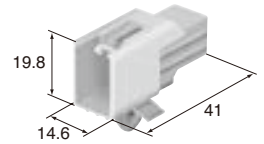
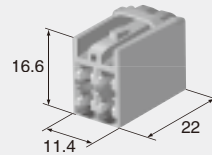

Plate thickness range for clamp:
t=0.6~2.0mm
Hole=7.2mm×10.2mm

M (6098-3452)**F (6098-8480)**

Color 颜色	Natural 自然色
--------------------	----------------

1.5mm, 2.8mm (060, 110)

Housing (UNIT : mm)

Ref: Terminal part No.	[1.5mm]	I-02
端子参照页	[2.8mm]	I-08

Material	PBT
材质	

No. of way/ () corresponds to 1.5mm, 2.8mm, in order from left to right.
Note) Connector can be used together with 2mm² wire are 14 poled connectors.

For details of each product, please contact our sales staff.

极数 / () 内显示: 1.5mm 极数、2.8mm 极数

※ L 尺寸端子的可用接插件有限制。

务必向敝公司销售负责人问讯。

SL SERIES for HYBRID

14way (10+4)

Color	Natural
颜色	自然色

Note)

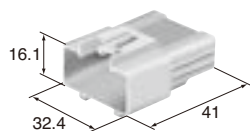

M (6098-3450)

F (6098-3458)

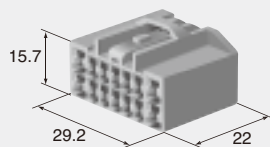

Note)

Color	Natural
颜色	自然色