

TS SEALED SERIES

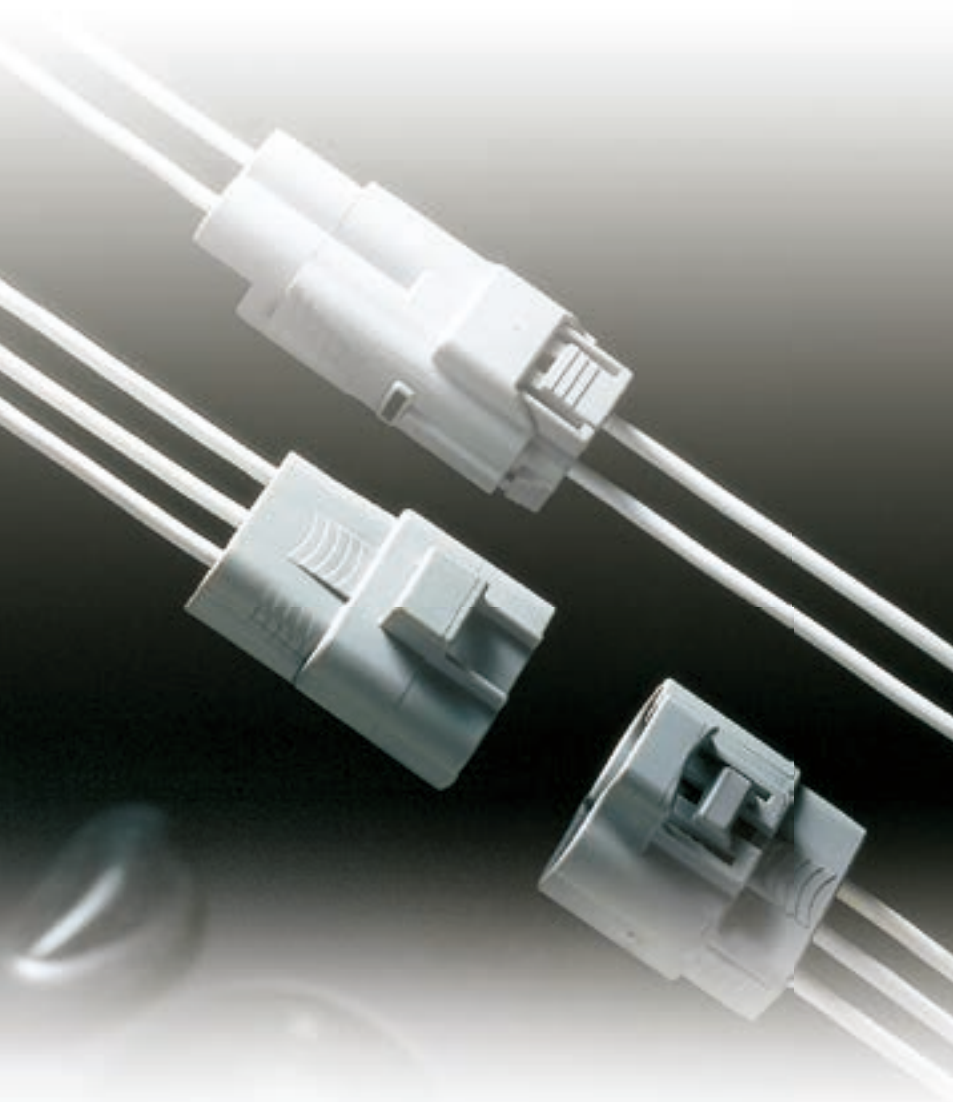

Features

The TS sealed connector series has a mechanism of terminal position assurance. This series consists of 0.64mm, 2.3mm, 4.8mm and 8.0mm types classified according to terminal size, covering an extensive array of applications from signal to power circuits.

- Retainers are pre-mounted on the connector housing, and are structured to enable setting by the same simple operation regardless of the number of ways, improving operability.
- These connectors can be directly secured to a bracket on the car body.
- RoHS/ELV Compliant

特点

TS防水系列接插件具有检测端子插入不足的结构。按照端子尺寸划分为0.64mm·2.3mm·4.8mm·8.0mm，从信号回路到电源回路，能广泛应用。

- 锁片预先组装在接插件护套上，无论多少极数都能通过简单操作组合，有助于提高操作效率。
- 接插件可以直接固定在车体的支架上。
- 可对应欧盟 RoHS 和 ELV 指令

TS SEALED SERIES for STANDARD

0.64mm (025)

Structure / 构造

B-02

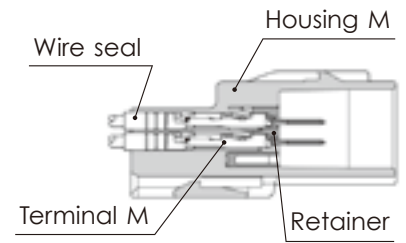
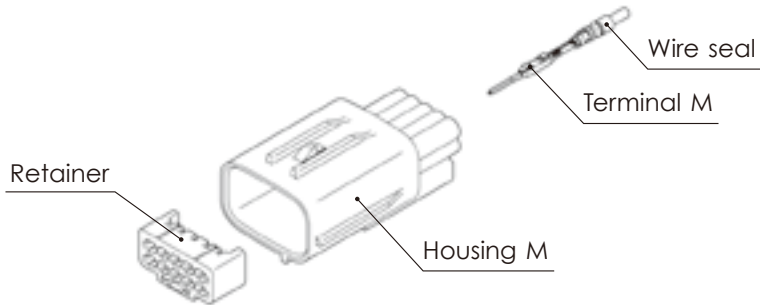

Connector M

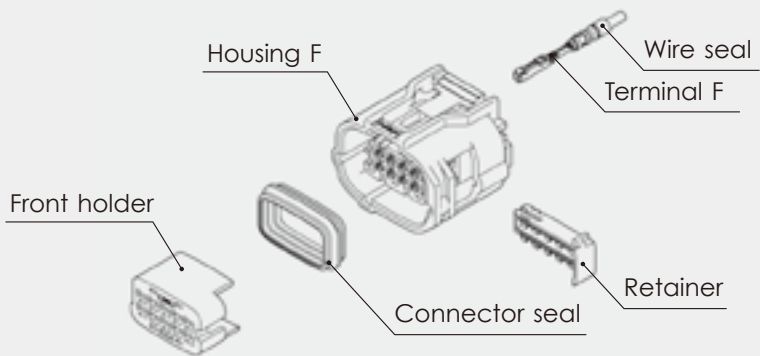

Connector F

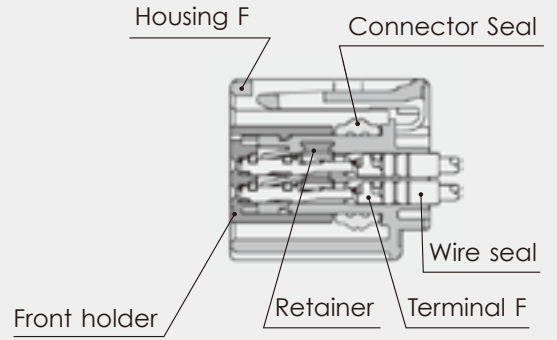

0.64mm (025)

Terminal (UNIT : mm)

端子 (毫米)

(S)

F (8240-0336)

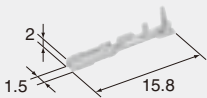

Cable size (mm²) 适用电线大小	0.13
Material 材质	Heat-resistant copper alloy
Surface treatment 表面处理	Tin-plated 镀锡

(S)

Au

F (8240-0337)

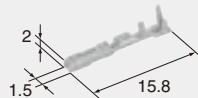

Cable size (mm²) 适用电线大小	0.13
Material 材质	Heat-resistant copper alloy
Surface treatment 表面处理	Gold-plated 镀金

(M)

Cable size (mm²) 适用电线大小	0.22~0.5
Material 材质	Brass 黄铜
Surface treatment 表面处理	Tin-plated 镀锡

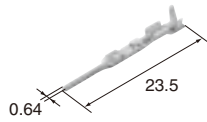

(M)

Au

Cable size (mm²) 适用电线大小	0.22~0.5
Material 材质	Brass 黄铜
Surface treatment 表面处理	Gold-plated 镀金

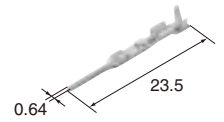

M (8100-3617)

F (8100-3455)

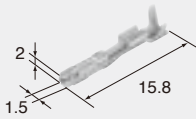

Cable size (mm²) 适用电线大小	0.22~0.35
Material 材质	Heat-resistant copper alloy
Surface treatment 表面处理	Tin-plated 镀锡

M (8100-3708)

F (8100-3456)

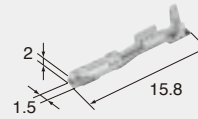

Cable size (mm²) 适用电线大小	0.22~0.35
Material 材质	Heat-resistant copper alloy
Surface treatment 表面处理	Gold-plated 镀金

(L)

F (8240-0287)

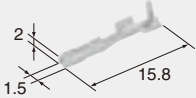

Cable size (mm²) 适用电线大小	0.5
Material 材质	Heat-resistant copper alloy
Surface treatment 表面处理	Tin-plated 镀锡

(L)

Au

F (8240-0288)

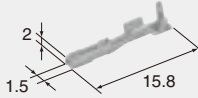

Cable size (mm²) 适用电线大小	0.5
Material 材质	Heat-resistant copper alloy
Surface treatment 表面处理	Gold-plated 镀金

0.64mm (025)

B-04

Wire seals (UNIT : mm)

电线密封栓(毫米)

- The wire seals are common to M and F.
*A wireseal depends on a chosen cable.
- 电线密封栓为公端、母端共用。
- ※不同的电线使用不同的电线密封栓。

(SS)

(7165-1043)

Cable size (mm ²) 适用电线大小	(CHFUS/0.22)
Cable overall diameter(mm) 带绝缘层外径	0.95~1.05
Material 材质	Silicon 硅
Color 颜色	Green 绿

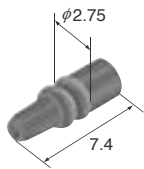

(3S)

(7165-1423)

Cable size (mm ²) 适用电线大小	(CHFUS/0.13)
Cable overall diameter(mm) 带绝缘层外径	0.85~0.95
Material 材质	Silicon 硅
Color 颜色	Light Brown 浅棕

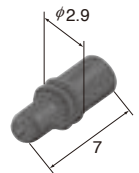

(S)

(7165-1312)

Cable size (mm ²) 适用电线大小	(CHFUS/0.35~0.5)
Cable overall diameter(mm) 带绝缘层外径	1.1~1.4
Material 材质	Silicon 硅
Color 颜色	Violet 紫

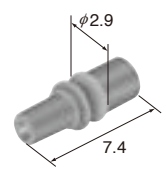

(M)

(7165-1198)

Cable size (mm ²) 适用电线大小	(AVSS/0.3) (AVSSH/0.3) (AESSX/0.3)
Cable overall diameter(mm) 带绝缘层外径	1.4~1.5
Material 材质	Silicon 硅
Color 颜色	Dark Yellow 深黄色

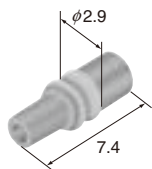

(L)

(7165-1199)

Cable size (mm ²) 适用电线大小	(AVSS/0.5) (AVSSH/0.5) (AVSSX/0.5) (AESSX/0.5)
Cable overall diameter(mm) 带绝缘层外径	1.6~1.7
Material 材质	Silicon 硅
Color 颜色	Red Violet 紫红

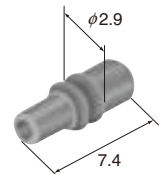

0.64mm (025)

Dummy plugs (UNIT : mm)

盲塞(毫米)

- Dummy plugs are common to M and F.
- Dummy plugs are used to blind unused terminal holes.
- 盲塞为公端、母端共用。
- 盲塞用于堵塞不使用的端子孔。

(7165-0797)

Material 材质	NBR
Color 颜色	Light Gray 浅灰



0.64mm (025)

Housing (UNIT : mm)

接插件护套(毫米)

Ref: Terminal part No. B-03
端子参照页

Ref: wire seal No. B-04
电线密封栓参照页

Ref: Dummy plug No. B-04
盲塞参照页

Material PBT
材质

2way

Color Black
颜色 黑

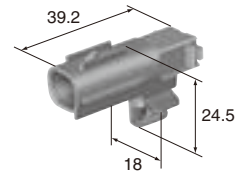

M (6188-4797)

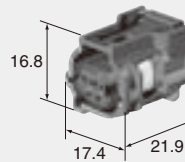

F (6189-1161)

Color Black
颜色 黑

2way

F (6189-7020)

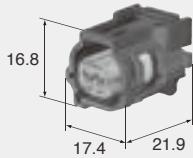

Color Black
颜色 黑

3way

Color Black
颜色 黑

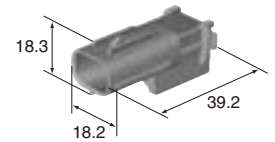

M (6188-4920)

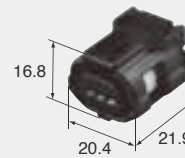

F (6189-1129)

Color Black
颜色 黑

2way

F (6189-7073)

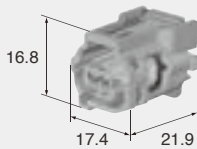

Color Gray
颜色 灰

4way

F (6189-1132)

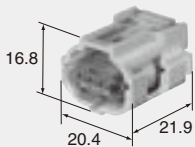

Color Gray
颜色 灰

4way

F (6189-1231)

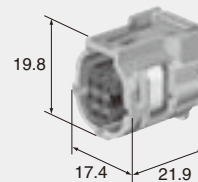

Color Gray
颜色 灰

4way

F (6189-7401)

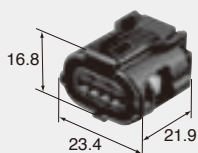

Color Black
颜色 黑

5way

F (6189-1046)

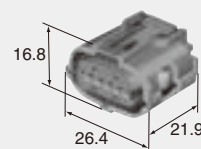

Color Black
颜色 黑

6way

Color 颜色 Natural 自然色

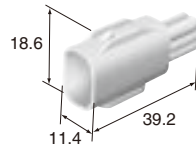

6way

F (6189-1083)

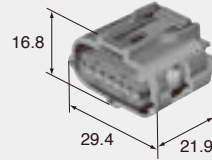

Color 颜色 Black 黑

M (6188-0706)

F (6189-1142)

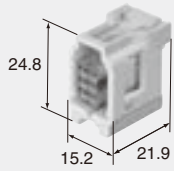

Color 颜色 Natural 自然色

6way

F (6189-7100)

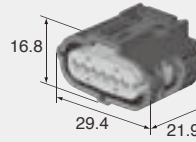

Color 颜色 Black 黑

8way

Color 颜色 Gray 灰

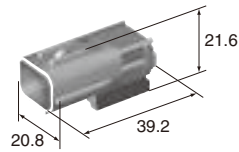

M (6188-0779)

F (6189-1240)

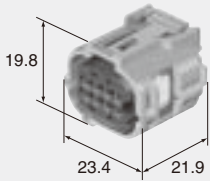

Color 颜色 Gray 灰

10way

Color 颜色 Black 黑

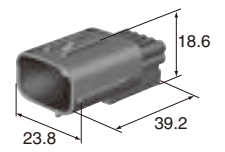

M (6188-0696)

F (6189-1134)

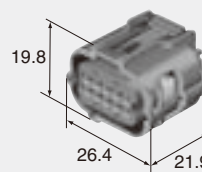

Color 颜色 Black 黑

12way

F (6189-1128)

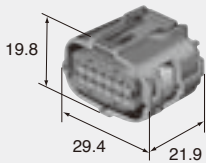

Color 颜色 Black 黑

13way

Color 颜色 Gray 灰

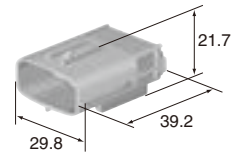

12way

F (6189-1133)

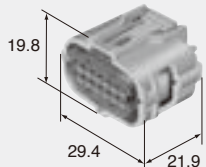

Color 颜色 Gray 灰

M (6188-4914)

F (6189-1092)

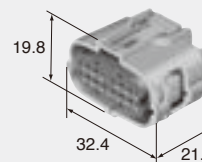

Color 颜色 Gray 灰

15way **F (6189-1135)**

Color: Gray
颜色: 灰

17way **F (6189-7110)**

Color: Gray
颜色: 灰

20way **F (6189-7167)**

Color: Black
颜色: 黑

30way **F (6189-6987)**

Color: Gray
颜色: 灰

B-07

TS SEALED SERIES

TS SEALED SERIES for STANDARD

0.64W (025W)

Structure / 构造

B-08

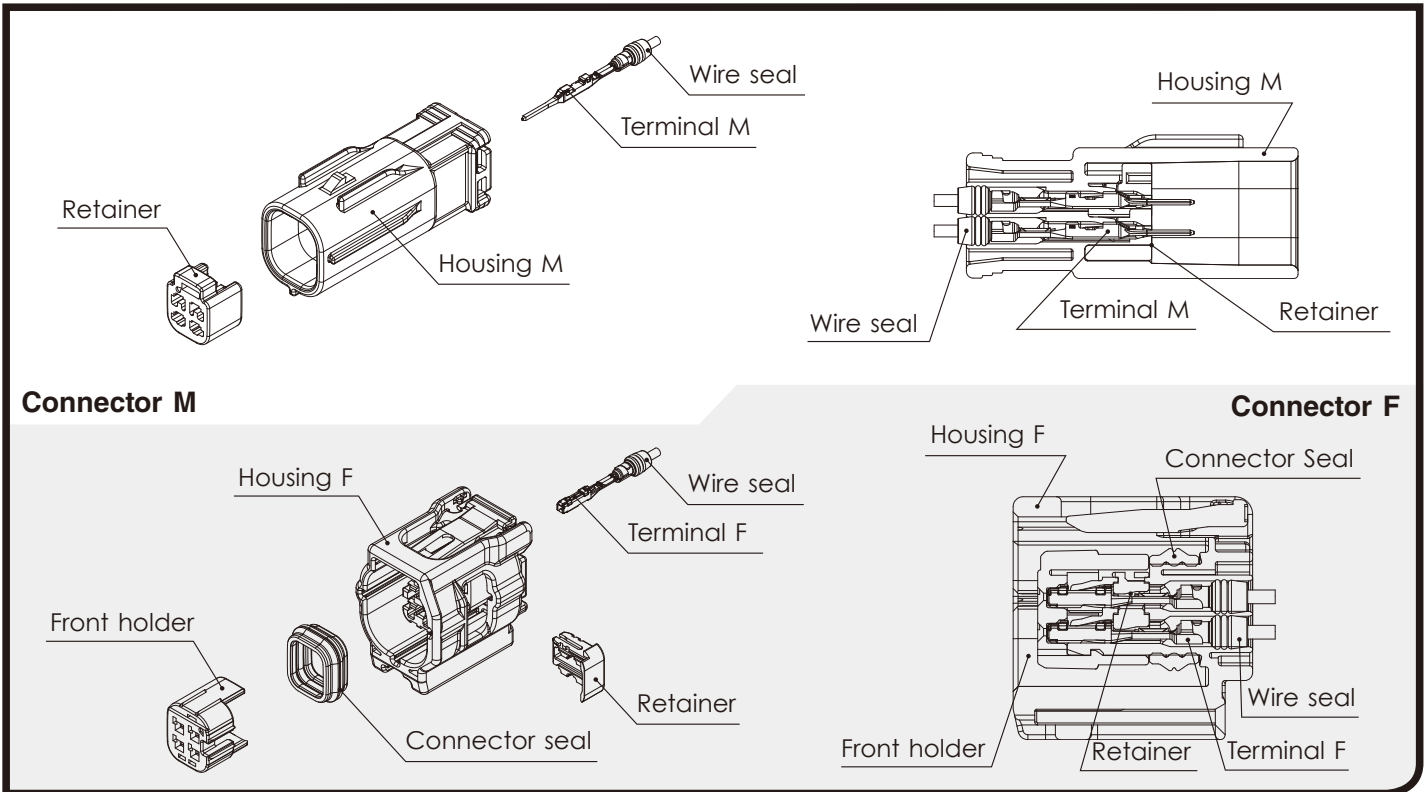

防水0.64W型接插件与0.64型相比，因为扩大了端子孔腔间的距离，所以不具备互换性。

(为了区别于现有的防水0.64型，称呼为防水0.64W型。)

Since 0.64W has wider terminal pitch, there is no compatibility between 0.64 and 0.64W.

(These connectors are called "0.64W series" to distinguish from existing 0.64 series.)

0.64W (025W)

Terminal (UNIT: mm)

端子(毫米)

Ref; 0.64mm Terminal detail

0.64mm端子参照页

M(Sn) M (8100-3617) B-03 **F (8100-3455)** B-03

M(Au) M (8100-3708) B-03 **F (8100-3456)** B-03

(LL)

Cable size (mm²)
适用电线大小

FPW/0.6	CIVUS/0.5
AVSS/0.5	AVSSX/0.5
AVSSH/0.5	IVSSH/0.5
AESSX/0.5	CHFUS/0.5
HFSS/0.5	

Material
材质

Brass

Surface treatment
表面处理

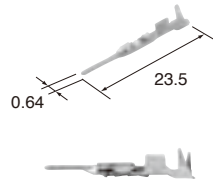
Tin-plated
镀锡**(LL)****Au**

Cable size (mm²)
适用电线大小

CIVUS/0.5	AVSS/0.5
AVSSX/0.5	AVSSH/0.5
IVSSH/0.5	AESSX/0.5
CHFUS/0.5	HFSS/0.5

Material
材质

Brass
黄铜

Surface treatment
表面处理

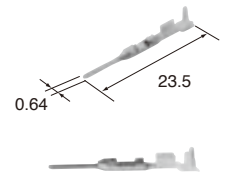
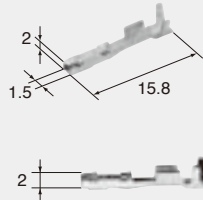
Gold-plated
镀金**M (8230-5360)****F (8240-0500)**

Cable size (mm²)
适用电线大小

FPW/0.6	CIVUS/0.5
AVSS/0.5	AVSSX/0.5
AVSSH/0.5	IVSSH/0.5
AESSX/0.5	CHFUS/0.5
HFSS/0.5	

Material
材质

Heat resistant copper-alloy
耐热铜合金

Surface treatment
表面处理

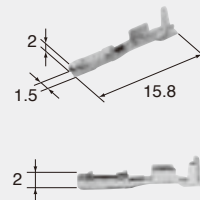
Tin-plated
镀锡**M (8230-5361)****F (8240-0501)**

Cable size (mm²)
适用电线大小

CIVUS/0.5	AVSS/0.5
AVSSX/0.5	AVSSH/0.5
IVSSH/0.5	AESSX/0.5
CHFUS/0.5	HFSS/0.5

Material
材质

Heat resistant copper-alloy
耐热铜合金

Surface treatment
表面处理

Gold-plated
镀金

0.64W (025W)

Wire seals (UNIT : mm)

电线密封栓(毫米)

The wire seals are common to M and F.

电线密封栓为公端、母端共用。

(S)**(7165-1608)**

Cable size (mm²)
适用电线大小

CIVUS/0.35~0.5
CHFUS/0.35~0.5

Cable overall diameter (mm)
带绝缘层外径

1.1~1.4

Material
材质

Silicon
硅

Color
颜色

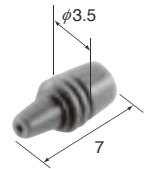
Dark Gray
深灰**(M)****(7165-1607)**

Cable size (mm²)
适用电线大小

AVSS/0.3	AVSSH/0.3
IVSSH/0.35	HFSS/0.35

Cable overall diameter (mm)
带绝缘层外径

1.3~1.5

Material
材质

Silicon
硅

Color
颜色

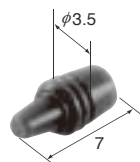
Dark Green
墨绿**(L)****(7165-1606)**

Cable size (mm²)
适用电线大小

FPW/0.6	AVSS/0.5
AVSSX/0.5	AVSSH/0.5
IVSSH/0.5	HFSS/0.5

Cable overall diameter (mm)
带绝缘层外径

1.51~1.73

Material
材质

Silicon
硅

Color
颜色

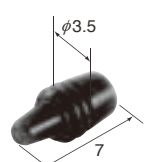
Dark Brown
深棕

0.64W (025W)

B-10

Dummy plugs (UNIT : mm)

盲塞(毫米)

- Dummy plugs are common to M and F.
- Dummy plugs are used to blind unused terminal holes.
- 盲塞为公端、母端共用。
- 盲塞用于堵塞不使用的端子孔。

0.64W (025W)

Housing (UNIT : mm)

接插件护套(毫米)

Ref: Terminal part No. B-08
端子参照页

Ref: wire seal No. B-09
电线密封栓参照页

Ref: Dummy plug No. B-10
盲塞参照页

Material PA6T
材质

TS SEALED SERIES
for HYBRID

(7165-1605)

Material Silicon
材质 硅

Color Indian Red
颜色 印度红

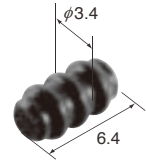

4way

Color Black
颜色 黑

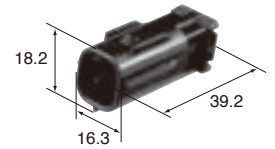

M (6188-5516)

F (6189-7449)

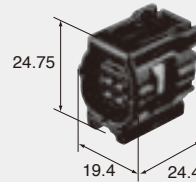

Color Black
颜色 黑

0.64W, 2.3mm, 4.8mm (025W, 090, 187)

Housing (UNIT : mm)

接插件护套(毫米)

Ref: Terminal part No. [0.64W] B-08
端子参照页 [2.3mm] B-13(for P06)
[4.8mm] B-19

Ref: wire seal No. [0.64W] B-09
电线密封栓参照页 [2.3mm] B-14(for P06)
[4.8mm] B-20

Ref: Dummy plug No. [0.64W] B-10
盲塞参照页 [2.3mm] B-15(for P06)
[4.8mm] B-21

Material PBT
材质

No. of way/ () corresponds to 0.64W, 2.3mm, 4.8mm in order from left to right.
极数 / () 内显示 : 从左向右为0.64mm 极数、2.3mm 极数、4.8mm 极数

38way (34+2+2) Slide Lever
F (6189-7435)

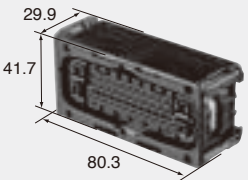

Color 颜色 Black 黒

38way (34+2+2) Slide Lever
F (6189-7436)

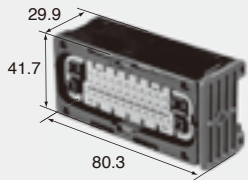

Color 颜色 Black 黒

38way (34+2+2) Swing + Slide Lever
F (6189-7433)

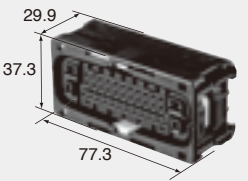

Color 颜色 Black 黒

38way (34+2+2) Swing + Slide Lever
F (6189-7434)

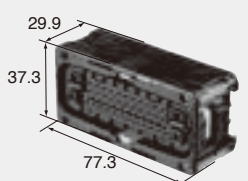

Color 颜色 Black 黒

Lever Assy
F (6911-5774)

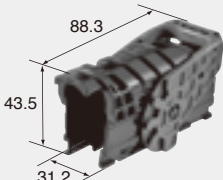

Color 颜色 Black 黒

46way (38+4+4) Slide Lever
F (6189-7546)

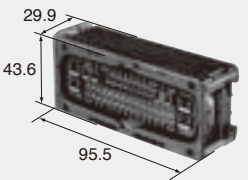

Color 颜色 Black 黒

46way (38+4+4) Slide Lever
F (6189-7547)

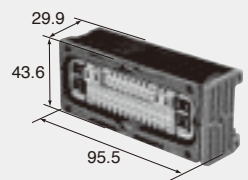

Color 颜色 Black 黒

TS SEALED SERIES for STANDARD

2.3mm (090)

Structure / 构造

B-12

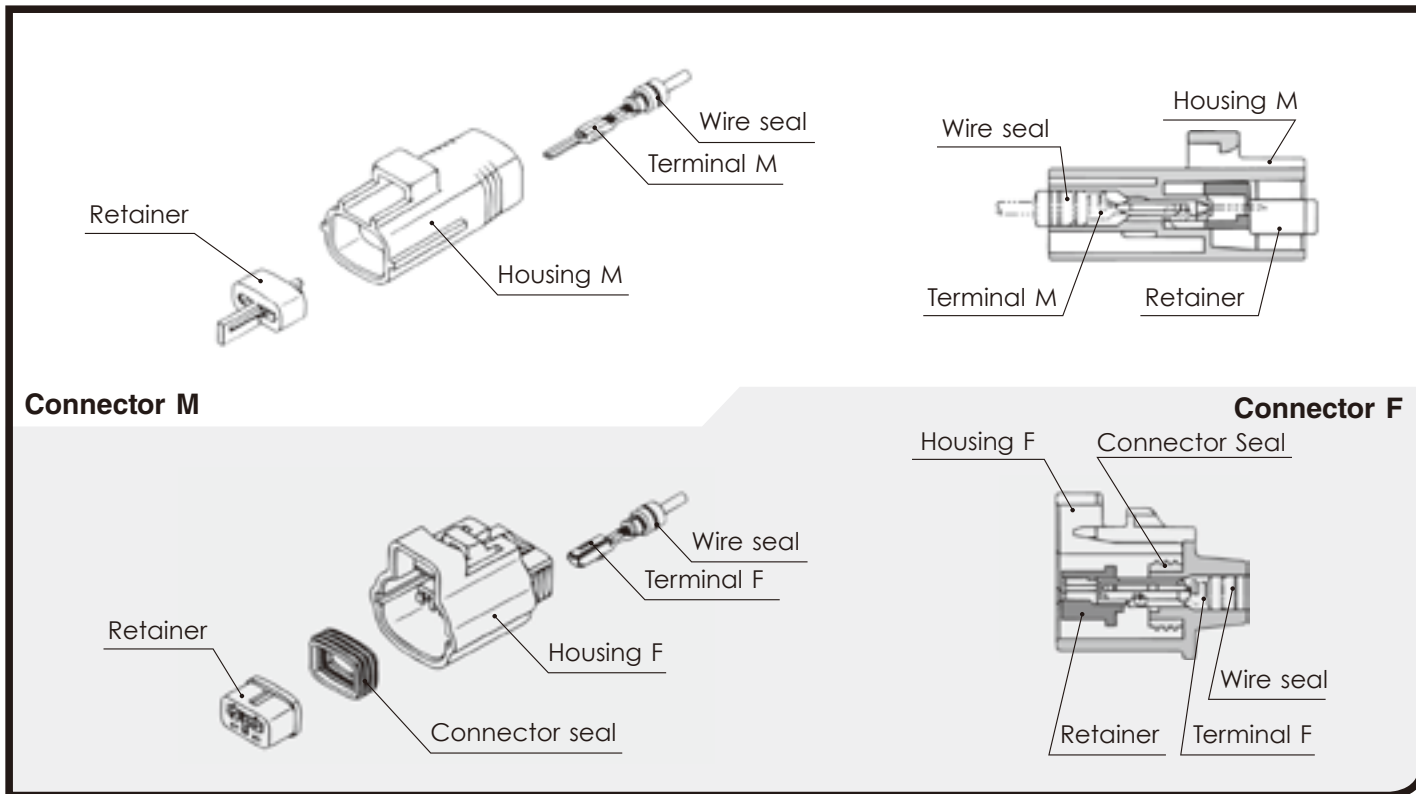

2.3mm (090)

Terminal (UNIT: mm)

端子(毫米)

(S)

Cable size (mm²) 适用电线大小	0.3~0.5
Material 材质	Brass 黄铜
Surface treatment 表面处理	Tin-plated 镀锡

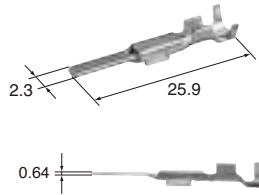
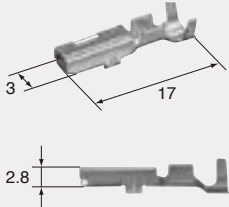
**M (8100-0457)**

Cable size (mm²) 适用电线大小	0.3~0.5
Material 材质	Heat-resistant copper alloy
Surface treatment 表面处理	Tin-plated 镀锡

F (8100-0460)**(S)**

Cable size (mm²) 适用电线大小	0.3~0.5
Material 材质	Brass 黄铜
Surface treatment 表面处理	Gold-plated 镀金

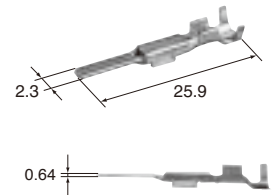
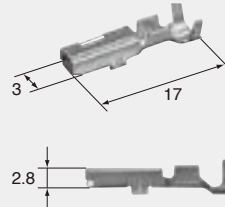
**M (8100-1340)**

Cable size (mm²) 适用电线大小	0.3~0.5
Material 材质	Heat-resistant copper alloy
Surface treatment 表面处理	Gold-plated 镀金

F (8100-1344)**(M)**

Cable size (mm²) 适用电线大小	0.5~1.25
Material 材质	Brass 黄铜
Surface treatment 表面处理	Tin-plated 镀锡

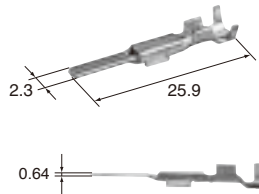
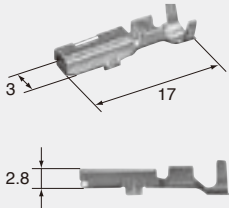
**M (8100-0458)**

Cable size (mm²) 适用电线大小	0.5~1.25
Material 材质	Heat-resistant copper alloy
Surface treatment 表面处理	Tin-plated 镀锡

F (8100-0461)**(M)**

Cable size (mm²) 适用电线大小	0.5~1.25
Material 材质	Brass 黄铜
Surface treatment 表面处理	Gold-plated 镀金

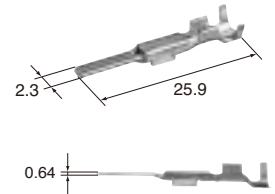
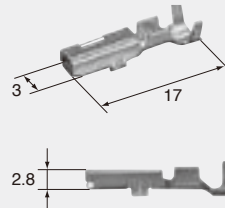
**M (8100-1007)**

Cable size (mm²) 适用电线大小	0.5~1.25
Material 材质	Heat-resistant copper alloy
Surface treatment 表面处理	Gold-plated 镀金

F (8100-0594)**(L)**

Cable size (mm²) 适用电线大小	2.0
Material 材质	Brass 黄铜
Surface treatment 表面处理	Tin-plated 镀锡

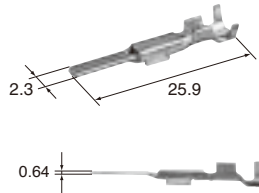
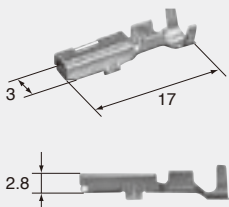
**M (8100-0459)**

Cable size (mm²) 适用电线大小	2.0
Material 材质	Heat-resistant copper alloy
Surface treatment 表面处理	Tin-plated 镀锡

F (8100-0462)**(L)**

Cable size (mm²) 适用电线大小	2.0
Material 材质	Brass 黄铜
Surface treatment 表面处理	Gold-plated 镀金

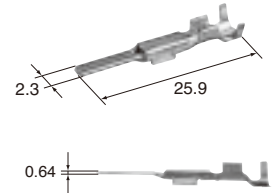
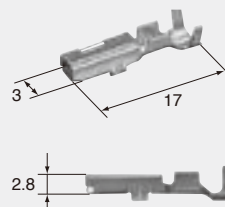
**M (8100-1008)**

Cable size (mm²) 适用电线大小	2.0
Material 材质	Heat-resistant copper alloy
Surface treatment 表面处理	Gold-plated 镀金

F (8100-0817)**Au****B-13**

TS SEALED SERIES

2.3mm (090)

Wire seals (UNIT : mm)

电线密封栓(毫米)

The wire seals are common to M and F.

- P5 : For 5mm pitch housing/Please inquire us for the details.
- P6 : For 6mm pitch housing

电线密封栓为公端、母端共用。

- P5 : 5mm 间距用 / 请另行咨询。
- P6 : 6mm 间距用

(SS)

(P6)

(7165-0842)

Cable size (mm²) (适用电线大小) (CHFUS/0.35~0.5)

Cable overall diameter (mm) (带绝缘层外径) 1.1~1.4

Material (材质) Silicon (硅)

Color (颜色) Blue (蓝)

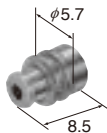

(S)

(P6)

(7165-0349)

Cable size (mm²) (适用电线大小) (AVX·AEX/0.3) (AVS/0.3) (AVSS/0.3~0.85) (AVSSX·AESSX/0.3~0.75) (CAVUS/0.85~1.25)

Cable overall diameter (mm) (带绝缘层外径) 1.4~2.0

Material (材质) Silicon (硅)

Color (颜色) Dark Brown (深棕)

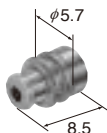

(S)

(P5)

(7165-0342)

Cable size (mm²) (适用电线大小) (AVX·AEX/0.3) (AVS/0.3) (AVSS/0.3~0.85) (AVSSX·AESSX/0.3~0.75) (CAVUS/0.85~1.25)

Cable overall diameter (mm) (带绝缘层外径) 1.4~2.0

Material (材质) Silicon (硅)

Color (颜色) Brown (棕)

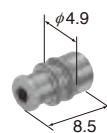

(M)

(P6)

(7165-0395)

Cable size (mm²) (适用电线大小) (AV/0.5) (AVX·AEX/0.5~0.75) (AVS/0.5~0.85) (AVSS/1.25) (AVSSX·AESSX/1.25)

Cable overall diameter (mm) (带绝缘层外径) 2.0~2.5

Material (材质) Silicon (硅)

Color (颜色) Dark Green (墨绿)

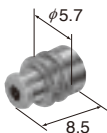

(M)

(P5)

(7165-0343)

Cable size (mm²) (适用电线大小) (AV/0.5) (AVX·AEX/0.5~0.75) (AVS/0.5~0.85) (AVSS/1.25) (AVSSX·AESSX/1.25)

Cable overall diameter (mm) (带绝缘层外径) 2.0~2.5

Material (材质) Silicon (硅)

Color (颜色) Black (黑)

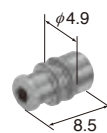

(L)

(P6)

(7165-0351)

Cable size (mm²) (适用电线大小) (AV/1.25) (AVX·AEX/1.25) (AVS/1.25) (AVSS/2.0) (AVSSX·AESSX/2.0)

Cable overall diameter (mm) (带绝缘层外径) 2.5~2.9

Material (材质) Silicon (硅)

Color (颜色) Dark Gray (深灰)

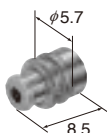

(L)

(P5)

(7165-0344)

Cable size (mm²) (适用电线大小) (AV/1.25) (AVX·AEX/1.25) (AVS/1.25) (AVSS/2.0) (AVSSX·AESSX/2.0)

Cable overall diameter (mm) (带绝缘层外径) 2.5~2.9

Material (材质) Silicon (硅)

Color (颜色) Dark Blue (藏青)

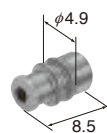

2.3mm (090)

Dummy plugs (UNIT : mm)

盲塞 (毫米)

- Dummy plugs are common to M and F.
- Dummy plugs are used to blind unused terminal holes.
- P5 : For 5mm pitch housing/Please inquire us for the details.
- P6 : For 6mm pitch housing
- 盲塞为公端、母端共用。
- 盲塞用于堵塞不使用的端子孔。
- P5 : 5mm 间距用 / 请另行咨询。
- P6 : 6mm 间距用

2.3mm (090)

Housing (UNIT : mm)

接插件护套 (毫米)

Ref: Terminal part No. B-13
端子参照页

Ref: wire seal No. B-14
电线密封栓参照页

Ref: Dummy plug No. B-15
盲塞参照页

Material PBT
材质

2way

Color Gray
颜色

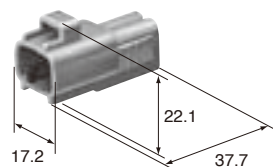

M (6188-0108)

F (6189-0199)

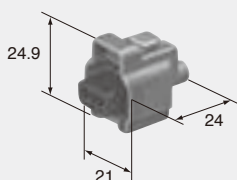

Color Gray
颜色

(P6)

(7160-9465)

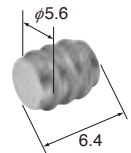

Material NBR
材质
Color Black
颜色

(P5)

(7161-9787)

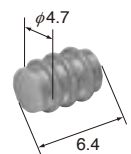

Material NBR
材质
Color Brown
颜色

2way

Color Gray
颜色

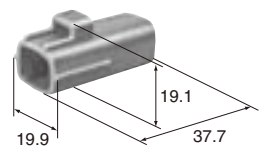

M (6188-0047)

F (6189-0100)

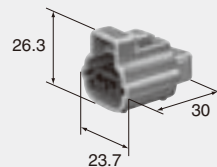

Color Gray
颜色

2way

Color Gray
颜色

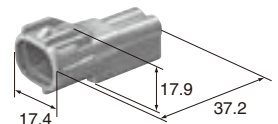

M (6188-0266)

F (6189-0249)

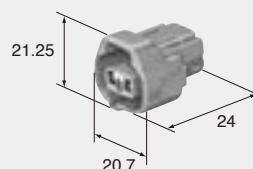

Color Gray
颜色

2way

Color	Gray
颜色	灰

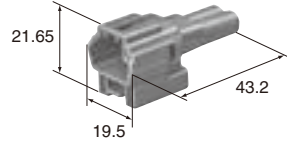
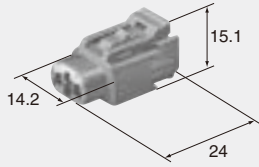
**M (6188-0229)****F (6189-0388)**

Color	Gray
颜色	灰

2way

Color	Natural
颜色	自然色

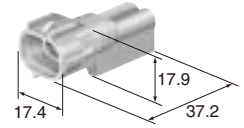
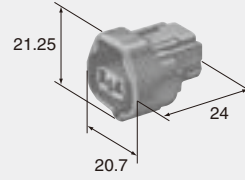
**M (6188-0624)****F (6189-0264)**

Color	Gray
颜色	灰

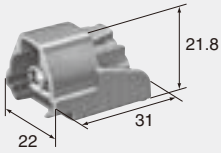
2way**P5****F (6189-0566)**

Ref: Wire seal No.	B-10 (For P5)
电线密封栓参照页	
Ref: Dummy plug No.	B-11 (For P5)
盲塞参照页	
Color	Gray
颜色	灰

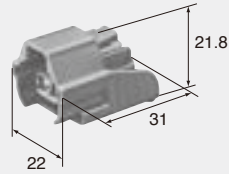
2way**P5****F (6189-0573)**

Ref: Wire seal No.	B-10 (For P5)
电线密封栓参照页	
Ref: Dummy plug No.	B-11 (For P5)
盲塞参照页	
Color	Gray
颜色	灰

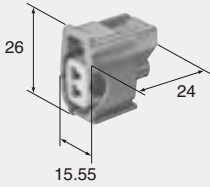
2way**P5****F (6189-0611)**

Ref: Wire seal No.	B-10 (For P5)
电线密封栓参照页	
Ref: Dummy plug No.	B-11 (For P5)
盲塞参照页	
Color	Gray
颜色	灰

2way

Color	Gray
颜色	灰

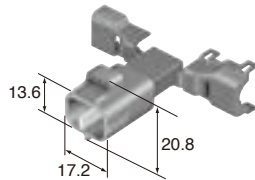
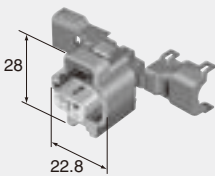
**M (6188-0470)****F (6189-0682)**

Color	Gray
颜色	灰

3way (T Type)

Color	Gray
颜色	灰

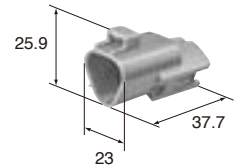
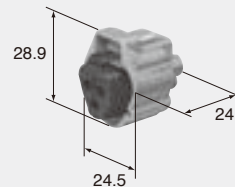
**M (6188-0099)****F (6189-0179)**

Color	Gray
颜色	灰

3way (E Type)

Color 灰
颜色 灰

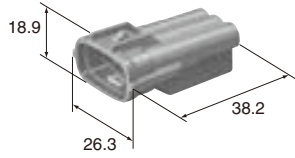

M (6188-0282)

F (6189-0443)

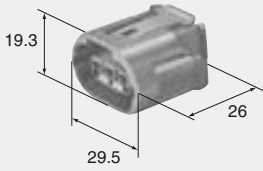

Color 灰
颜色 灰

4way

Color 黑
颜色 黑

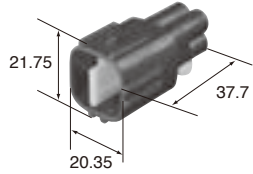

M (6188-0517)

F (6189-0629)

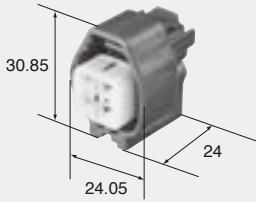

Color 灰
颜色 灰

4way

Color 灰
颜色 灰

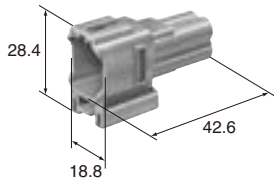

M (6188-0141)

F (6189-0381)

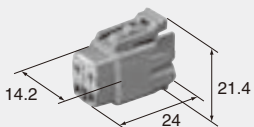

Color 灰
颜色 灰

4way

F (6189-0694)

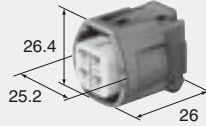

Color 黑
颜色 黑

4way

F (6189-7398)

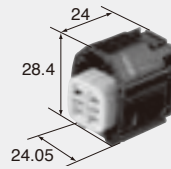

Material PA6T
颜色 黑

4way

Color 灰
颜色 灰

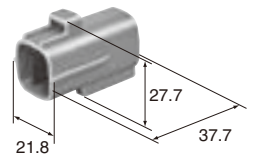

M (6188-0066)

F (6189-0126)

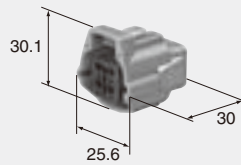

Color 灰
颜色 灰

4way

Color 灰
颜色 灰

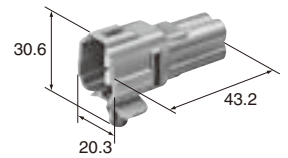
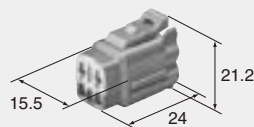

Plate thickness range for clamp:
t=0.7~2.2

M (6188-0217)

F (6189-0372)



Color 灰
颜色 灰

4way

Color 颜色 Gray 灰



M (6188-0472)

F (6189-0685)

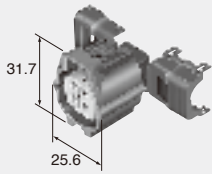

Color 颜色 Gray 灰

5way

Color 颜色 Gray 灰

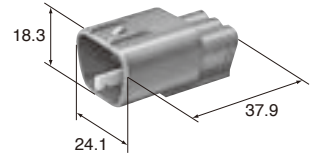

M (6188-0327)

F (6189-0504)

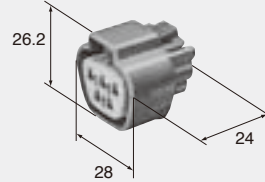

Color 颜色 Gray 灰

6way

Color 颜色 Gray 灰

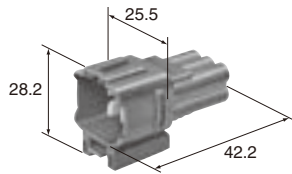

M (6188-0173)

F (6189-0319)

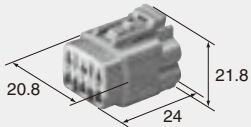

Color 颜色 Gray 灰

6way

Color 颜色 Gray 灰

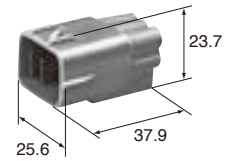

M (6188-0175)

F (6189-0323)

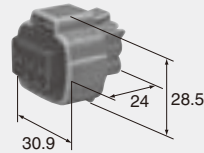

Color 颜色 Gray 灰

6way

Color 颜色 Gray 灰

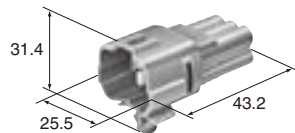
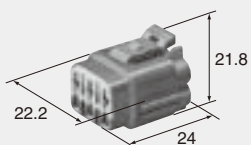

Plate thickness range for clamp:
t=0.7~2.2

M (6188-0209)

F (6189-0368)



Color 颜色 Gray 灰

7way

Color 颜色 Gray 灰

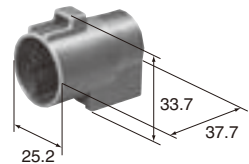

M (6188-0067)

F (6189-0127)

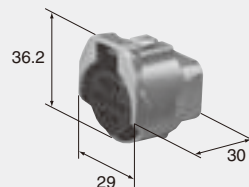

Color 颜色 Gray 灰

TS SEALED SERIES for STANDARD

4.8mm (187)

Structure / 构造

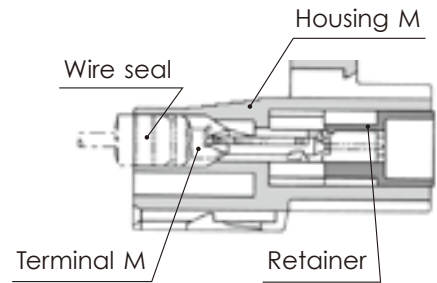
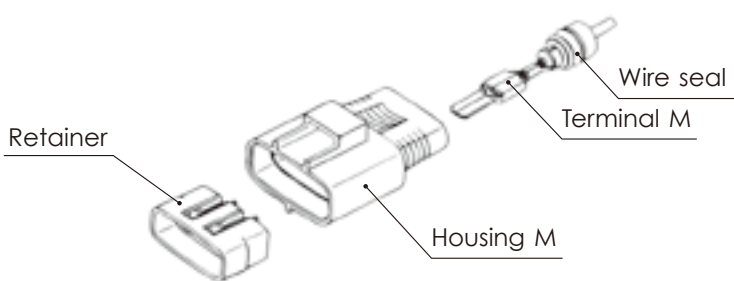

Connector M

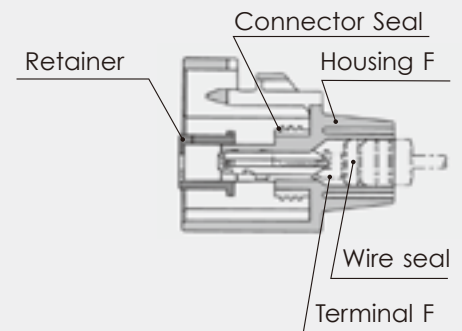
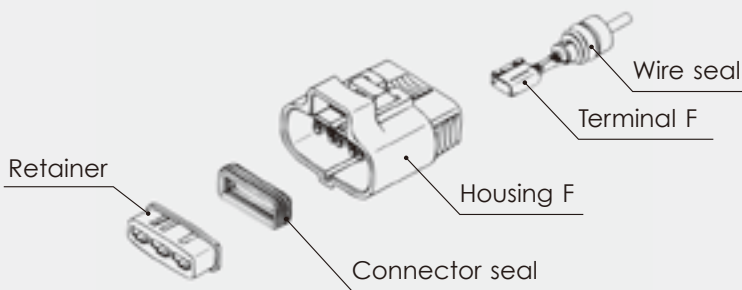

Connector F

B-19

TS SEALED SERIES

4.8mm (187)

(S)

Cable size (mm ²) 适用电线大小	0.3~0.5
Material 材质	Brass 黄铜
Surface treatment 表面处理	Tin-plated 镀锡

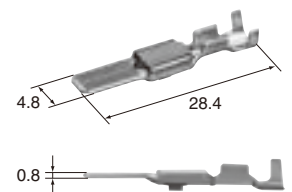

M (8100-0463)

F (8100-0466)

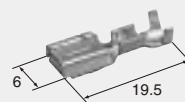

Cable size (mm ²) 适用电线大小	0.3~0.5
Material 材质	Brass 黄铜
Surface treatment 表面处理	Tin-plated 镀锡

Terminal (UNIT: mm)

端子(毫米)

(M)

Cable size (mm ²) 适用电线大小	0.5~1.25
Material 材质	Brass 黄铜
Surface treatment 表面处理	Tin-plated 镀锡

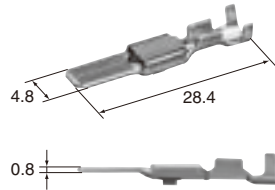
**(L)**

Cable size (mm ²) 适用电线大小	2.0~3.0
Material 材质	Brass 黄铜
Surface treatment 表面处理	Tin-plated 镀锡

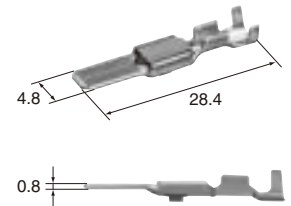
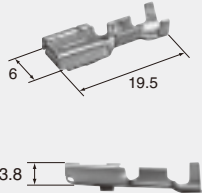
**B-20****M (8100-0464)****F (8100-0467)**

Cable size (mm ²) 适用电线大小	0.5~1.25
Material 材质	Brass 黄铜
Surface treatment 表面处理	Tin-plated 镀锡

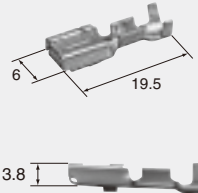
M (8100-0465)**F (8100-0468)**

Cable size (mm ²) 适用电线大小	2.0~3.0
Material 材质	Heat-resistant copper alloy
Surface treatment 表面处理	Tin-plated 镀锡

4.8mm (187)**Wire seals (UNIT : mm)**

电线密封栓(毫米)

The wire seals are common to M and F.

电线密封栓为公端、母端共用。

(S)**(7165-0346)**

Cable size (mm ²) 适用电线大小	(AVS/0.3) (AVSS/0.3~0.85) (AVSSX·AESSX/0.5~0.75) (CAVUS/0.85~1.25)
Cable overall diameter(mm) 带绝缘层外径	1.4~2.0
Material 材质	Silicon 硅
Color 颜色	Dark Brown 深棕

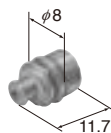
**(M)****(7165-0347)**

Cable size (mm ²) 适用电线大小	(AV/0.5~1.25) (AVX·AEX/0.5~1.25) (AVS/0.5~1.25) (AVSS/1.25~2.0) (AVSSX·AESSX/1.25~2.0)
Cable overall diameter(mm) 带绝缘层外径	2.0~2.9
Material 材质	Silicon 硅
Color 颜色	Dark Green 墨绿

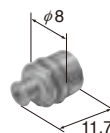
**(L)****(7165-0348)**

Cable size (mm ²) 适用电线大小	(AV/2.0) (AVX·AEX/2.0) (AVS/2.0)
Cable overall diameter(mm) 带绝缘层外径	2.9~3.5
Material 材质	Silicon 硅
Color 颜色	Dark Gray 深灰

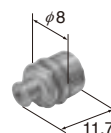
**(LL)****(7165-0356)**

Cable size (mm ²) 适用电线大小	(AV/3.0) (AVX·AEX/3.0) (AVS/3.0)
Cable overall diameter(mm) 带绝缘层外径	3.5~4.1
Material 材质	Silicon 硅
Color 颜色	Dark Blue 藏青

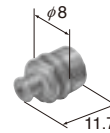

4.8mm (187)

Dummy plugs (UNIT : mm)

盲塞 (毫米)

- Dummy plugs are common to M and F.
- Dummy plugs are used to blind unused terminal holes.
- 盲塞为公端、母端共用。
- 盲塞用于堵塞不使用的端子孔。

(7165-0145)

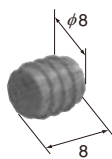

Material 材质	NBR
Color 颜色	Gray 灰

4.8mm (187)

Housing (UNIT : mm)

接插件护套 (毫米)

Ref: Terminal part No. 端子参照页	B-19
Ref: wire seal No. 电线密封栓参照页	B-20
Ref: Dummy plug No. 盲塞参照页	B-21
Material 材质	PBT

1way

Color 颜色	Gray 灰
-------------	-----------

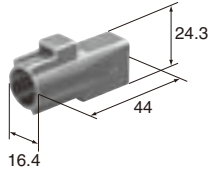

M (6188-0083) **F (6189-0145)**

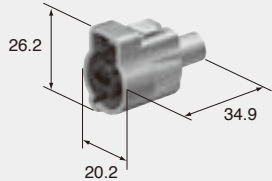

Color 颜色	Gray 灰
-------------	-----------

1way **F (6189-0413)**

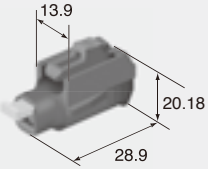

Color 颜色	Black 黑
-------------	------------

2way

Color 颜色	Gray 灰
-------------	-----------

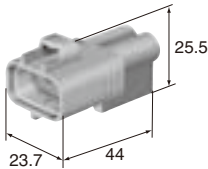

M (6188-0259) **F (6189-0425)**

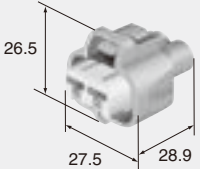

Color 颜色	Gray 灰
-------------	-----------

3way

Color Gray
颜色 灰

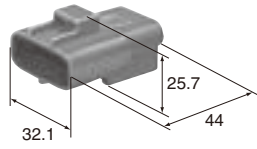

B-22

M (6188-0129)

F (6189-0165)

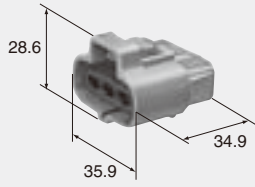

Color Gray
颜色 灰

TS SEALED SERIES for STANDARD

8.0mm (312)

Structure / 构造

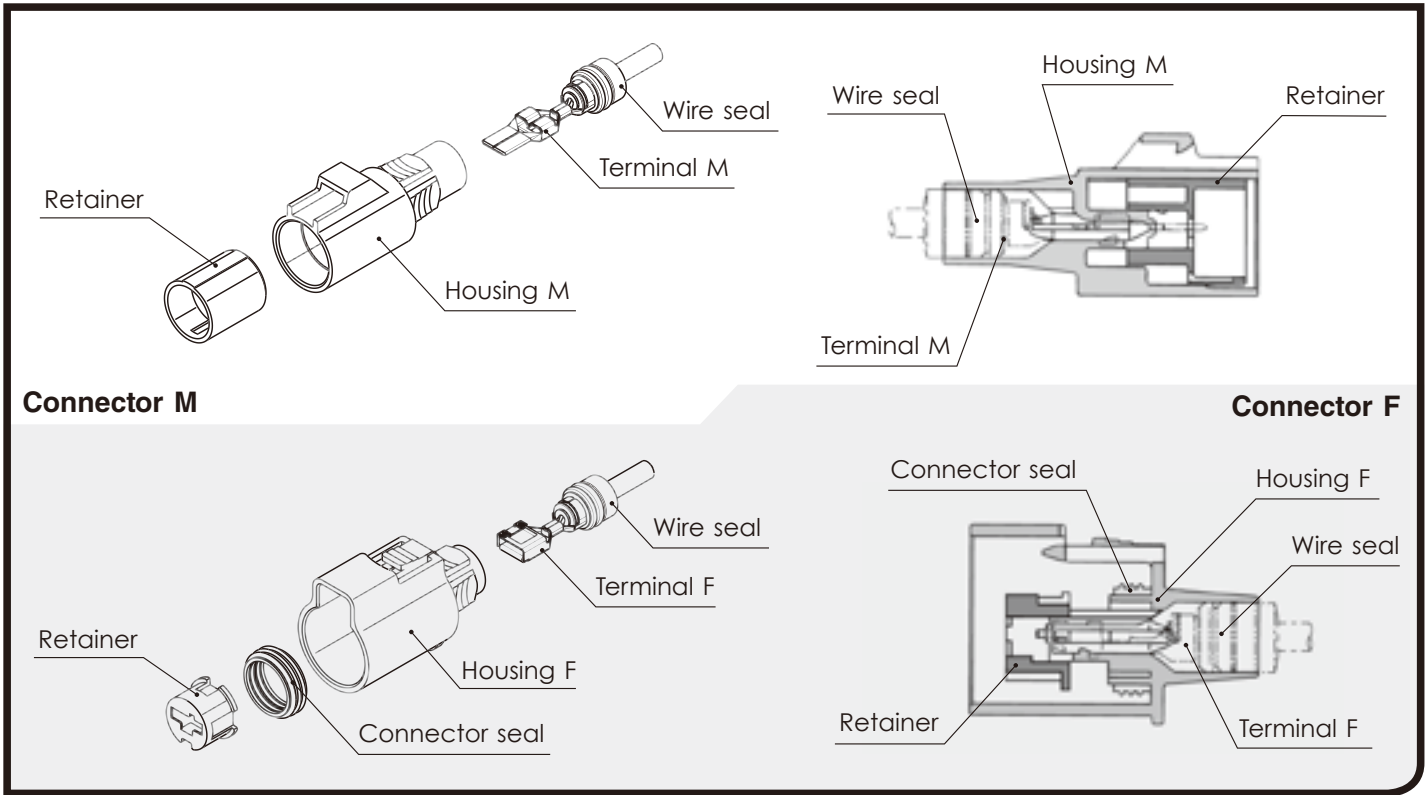

B-23

TS SEALED SERIES

8.0mm (312)

Terminal (UNIT: mm)

端子 (毫米)

(S)

Cable size (mm²) 适用电线大小 0.5~1.25

Cable overall diameter (mm) 带绝缘层外径 2.0~2.7

Material 材质 Brass 黄铜

Surface treatment 表面处理 Tin-plated 镀锡

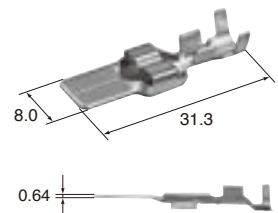

M (8100-0506)

F (8100-0451)

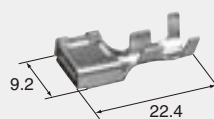

Cable size (mm²) 适用电线大小 0.5~1.25

Cable overall diameter (mm) 带绝缘层外径 2.0~2.7

Material 材质 Brass 黄铜

Surface treatment 表面处理 Tin-plated 镀锡

(M)Cable size (mm²) 2.0~3.0

适用电线大小

Cable overall diameter (mm) 2.6~4.1

带绝缘层外径

Material Brass

材质 黄铜

Surface treatment Tin-plated

表面处理 镀锡

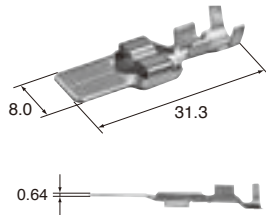
**(L)**Cable size (mm²) 5.0~8.0

适用电线大小

Cable overall diameter (mm) 4.4~5.8

带绝缘层外径

Material Brass

材质 黄铜

Surface treatment Tin-plated

表面处理 镀锡

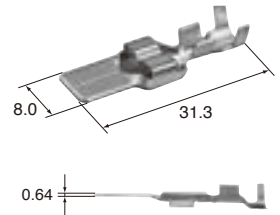

B-24

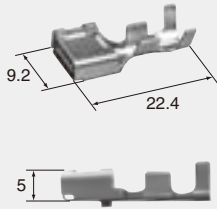
M (8100-0507)**F (8100-0452)**Cable size (mm²) 2.0~3.0

适用电线大小

Cable overall diameter (mm) 2.6~4.1

Material Brass

材质 黄铜

Surface treatment Tin-plated

表面处理 镀锡

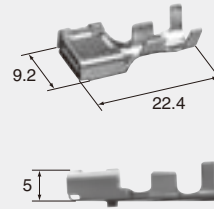
M (8100-0508)**F (8100-2980)**Cable size (mm²) 5.0~8.0

适用电线大小

Cable overall diameter (mm) 4.4~5.8

Material Heat-resistant

材质 copper alloy

Surface treatment Tin-plated

表面处理 镀锡

8.0mm (312)**Wire seals (UNIT : mm)**

电线密封栓(毫米)

The wire seals are common to M and F.

电线密封栓为公端、母端共用。

(SS)**(7165-0683)**Cable size (mm²) (AVS·AVX/0.5~1.25)

适用电线大小

Cable overall diameter (mm) Over 2.0 mm less than 2.9 mm

带绝缘层外径

Material Silicon

材质 硅

Color Dark Brown

颜色 深棕

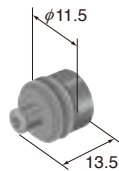
**(S)****(7165-0400)**Cable size (mm²) (AV/3.0) (AVX·AEX/3.0) (AVS/3.0)

适用电线大小

Cable overall diameter (mm) 3.6~4.1

带绝缘层外径

Material Silicon

材质 硅

Color Dark Gray

颜色 深灰

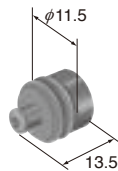
**(M)****(7165-0392)**Cable size (mm²) (AV/5.0) (AVX·AEX/5.0) (AVS/5.0)

适用电线大小

Cable overall diameter (mm) 4.4~4.9

带绝缘层外径

Material Silicon

材质 硅

Color Dark Blue

颜色 藏青

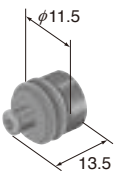
**(L)****(7165-0393)**Cable size (mm²) (AV/8.0) (AVX·AEX/8.0) (AVS/8.0)

适用电线大小

Cable overall diameter (mm) 5.3~5.8

带绝缘层外径

Material Silicon

材质 硅

Color Black

颜色 黑

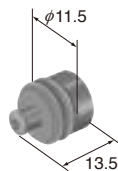

8.0mm (312)

Dummy plugs (UNIT : mm)

盲塞 (毫米)

- Dummy plugs are common to M and F.
- Dummy plugs are used to blind unused terminal holes.
- 盲塞为公端、母端共用。
- 盲塞用于堵塞不使用的端子孔。

(7165-0180)

Material 材质	NBR
Color 颜色	Gray 灰

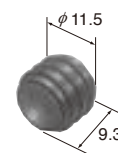

8.0mm (312)

Housing (UNIT : mm)

接插件护套 (毫米)

Ref: Terminal part No. 端子参照页	B-23
---------------------------------	------

Ref: wire seal No. 电线密封栓参照页	B-24
--------------------------------	------

Ref: Dummy plug No. 盲塞参照页	B-25
------------------------------	------

Material 材质	PBT
----------------	-----

1way

Color 颜色	Gray 灰
-------------	-----------

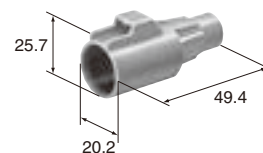

M (6188-0049)

F (6189-0101)

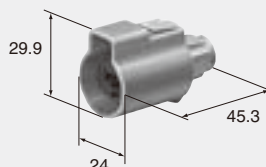

Color 颜色	Gray 灰
-------------	-----------

2way

Color 颜色	Gray 灰
-------------	-----------

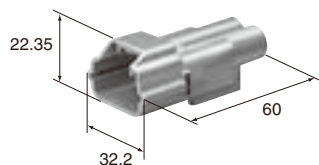

M (6188-0096)

F (6189-0172)

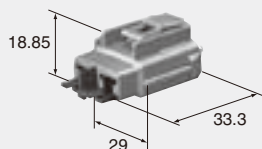

Color 颜色	Gray 灰
-------------	-----------

2way

F (6189-0856)

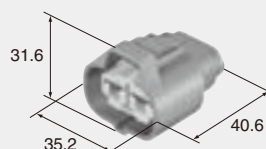

Color 颜色	Gray 灰
-------------	-----------

2way

F (6189-6953)

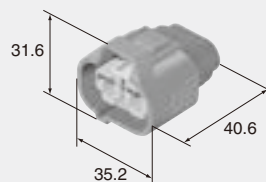

Color 颜色	Gray 灰
-------------	-----------

2way

Color
颜色

Gray
灰

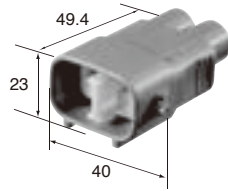

M (6188-5295)

F (6189-7256)

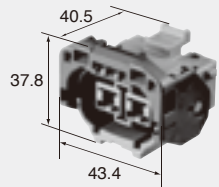

Color
颜色

Gray
灰

0.64mm, 2.3mm (025, 090)

Housing (UNIT : mm)

接插件护套(毫米)

Ref: Terminal part No. [0.64mm] B-03
端子参照页 [2.3mm] B-13

Ref: wire seal No. [0.64mm] B-04
电线密封栓参照页 [2.3mm] B-14

Ref: Dummy plug No. [0.64mm] B-04
盲塞参照页 [2.3mm] B-15

Material PBT
材质

No. of way/ () corresponds to 0.64mm, 2.3mm, in order from left to right.
极数 / () 内显示: 从左向右为0.64mm 极数、2.3mm 极数

TS SEALED SERIES for HYBRID

10way (6+4)

F (6189-7691)

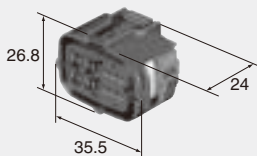

Color
颜色

Black
黑

13way (10+3)

F (6189-7077)

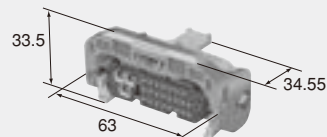

Color
颜色

Gray
灰

26way (23+3)

F (6189-6934)

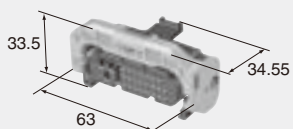

Color
颜色

Black
黑

0.64mm, 4.8mm
(025, 187)

Housing (UNIT : mm)

接插件护套(毫米)

Ref: Terminal part No. [0.64mm] B-03
端子参照页 [4.8mm] B-19

Ref: wire seal No. [0.64mm] B-04
电线密封栓参照页 [4.8mm] B-20

Ref: Dummy plug No. [0.64mm] B-04
盲塞参照页 [4.8mm] B-21

Material PBT
材质

No. of way () corresponds to 0.64mm, 4.8mm, in order from left to right.
极数 / () 内显示 : 从左向右为0.64mm 极数、4.8mm 极数

4way (2+2)

Color Black
颜色 黑

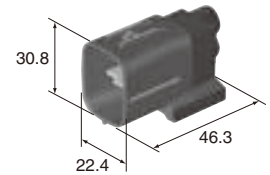

M (6188-5103)

F (6189-1048)

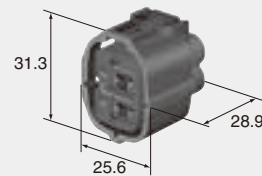

Color Black
颜色 黑

24way (22+2)

F (6189-7426)

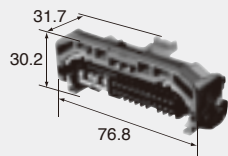

Color Gray
颜色 灰

34way (30+4)

F (6189-6978)

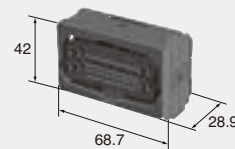

Color Black
颜色 黑

34way (30+4)

F (6189-6979)

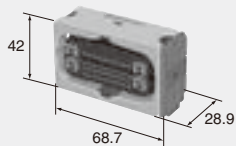

Color Gray
颜色 灰

34way (30+4)

F (6189-6980)

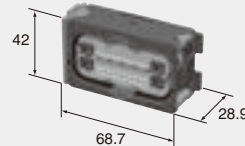

Color Black
颜色 黑

34way (30+4)

F (6189-6981)

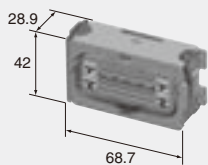

Color Gray
颜色 灰

40way (36+4)

F (6189-1160)

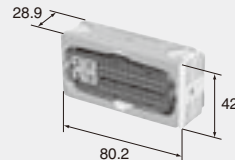

Color Gray
颜色 灰

46way (42+4)

F (6189-1136)

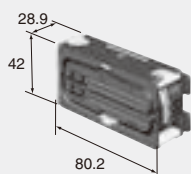

Color Black
颜色 黑

46way (42+4)

F (6189-6894)

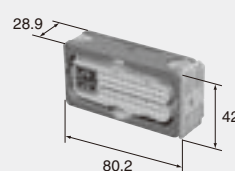

Color Black
颜色 黑

0.64mm, 2.3mm, 4.8mm (025, 090, 187)

Housing (UNIT : mm)

接插件护套(毫米)

Ref: Terminal part No. 端子参照页	[0.64mm]	B-03
	[2.3mm]	B-13
	[4.8mm]	B-19

Ref: wire seal No. 电线密封栓参照页	[0.64mm]	B-04
	[2.3mm]	B-14
	[4.8mm]	B-20

Ref: Dummy plug No. 盲塞参照页	[0.64mm]	B-04
	[2.3mm]	B-15
	[4.8mm]	B-21

Material
材质 PBT

No. of way/ () corresponds to 0.64mm, 2.3mm, 4.8mm in order from left to right.
极数 / () 内显示 : 从左向右为0.64mm 极数、2.3mm 极数、4.8mm 极数

B-28

42way (36+2+4)

F (6189-7094)

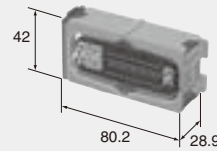

Color
颜色 Black
黑

52way (42+4+6)

F (6189-7809)

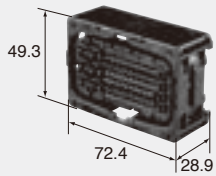

Color
颜色 Black
黑

Lever Assy

(6911-5948)

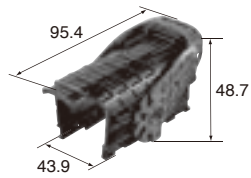

Color
颜色 Black
黑

2.3mm, 4.8mm (090, 187)

Housing (UNIT : mm)

接插件护套(毫米)

Ref: Terminal part No. 端子参照页	[2.3mm] B-13 [4.8mm] B-19
Ref: wire seal No. 电线密封栓参照页	[2.3mm] B-14 (For P6) [4.8mm] B-20
Ref: Dummy plug No. 盲塞参照页	[2.3mm] B-15 (For P6) [4.8mm] B-21

Material
材质 PBT

No. of way/ () corresponds to 2.3mm, 4.8mm in order from left to right.
极数 / () 内显示 : 从左向右为2.3mm 极数、4.8mm 极数

4way (2+2)

Color Gray
颜色 灰

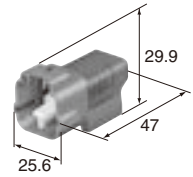

M (6188-0415)

F (6189-0144)

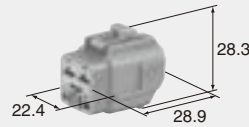

Color Gray
颜色 灰

5way (3+2)

Color Gray
颜色 灰

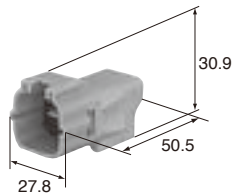

M (6188-0091)

F (6189-0166)

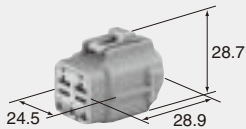

Color Gray
颜色 灰

5way (3+2)

Color Gray
颜色 灰

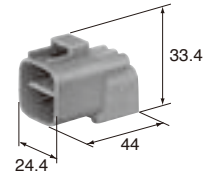

M (6188-0101)

F (6189-0181)

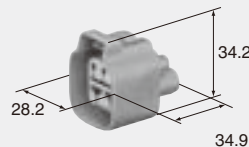

Color Gray
颜色 灰

6way (4+2)

Color Gray
颜色 灰

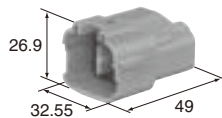

M (6188-0187)

F (6189-0143)

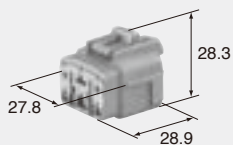

Color Gray
颜色 灰

11way (8+3)

Color Gray
颜色 灰

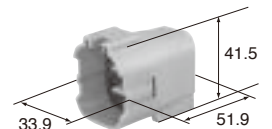

M (6188-0221)

F (6189-0376)

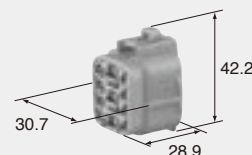

Color Gray
颜色 灰

4.8mm, 8.0mm
(187, 312)

Housing (UNIT : mm)

接插件护套(毫米)

Ref: Terminal part No. [4.8mm] B-19
端子参照页 [8.0mm] B-23

Ref: wire seal No. [4.8mm] B-20
电线密封栓参照页 [8.0mm] B-24

Ref: Dummy plug No. [4.8mm] B-21
盲塞参照页 [8.0mm] B-25

Material
材质 PBT

No. of way/ () corresponds to 4.8mm, 8.0mm in order from left to right.
极数 / () 内显示 : 从左向右为4.8mm 极数、8.0mm 极数

3way (1+2)

F (6189-7156)

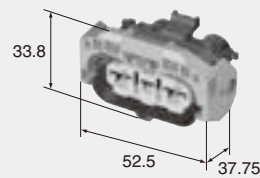

Color
颜色

Black
黑