

DL SERIES



Features

The DL connector series has a mechanism that detects when terminals are not inserted completely.

The connector mechanism only allows the retainer to be set when the terminal is completely inserted.

These connectors can be directly secured to a bracket on the car body.

特長

DLシリーズは、挿入不足のターミナルを検知する機構を備えたコネクタシリーズです。ターミナルが半挿入の状態では、リテーナが装着できない機構になっています。コネクタはボデー側のブラケットに直接固定することができます。

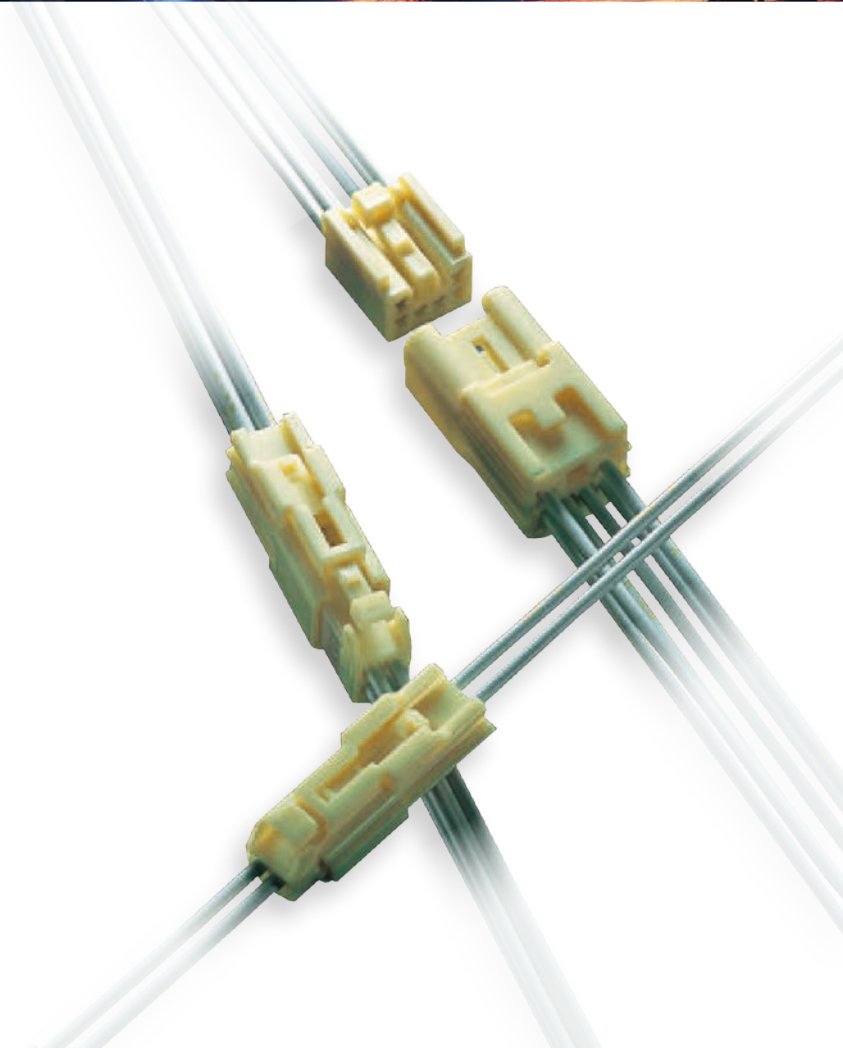

DL SERIES for STANDARD

0.64mm (025)

Structure

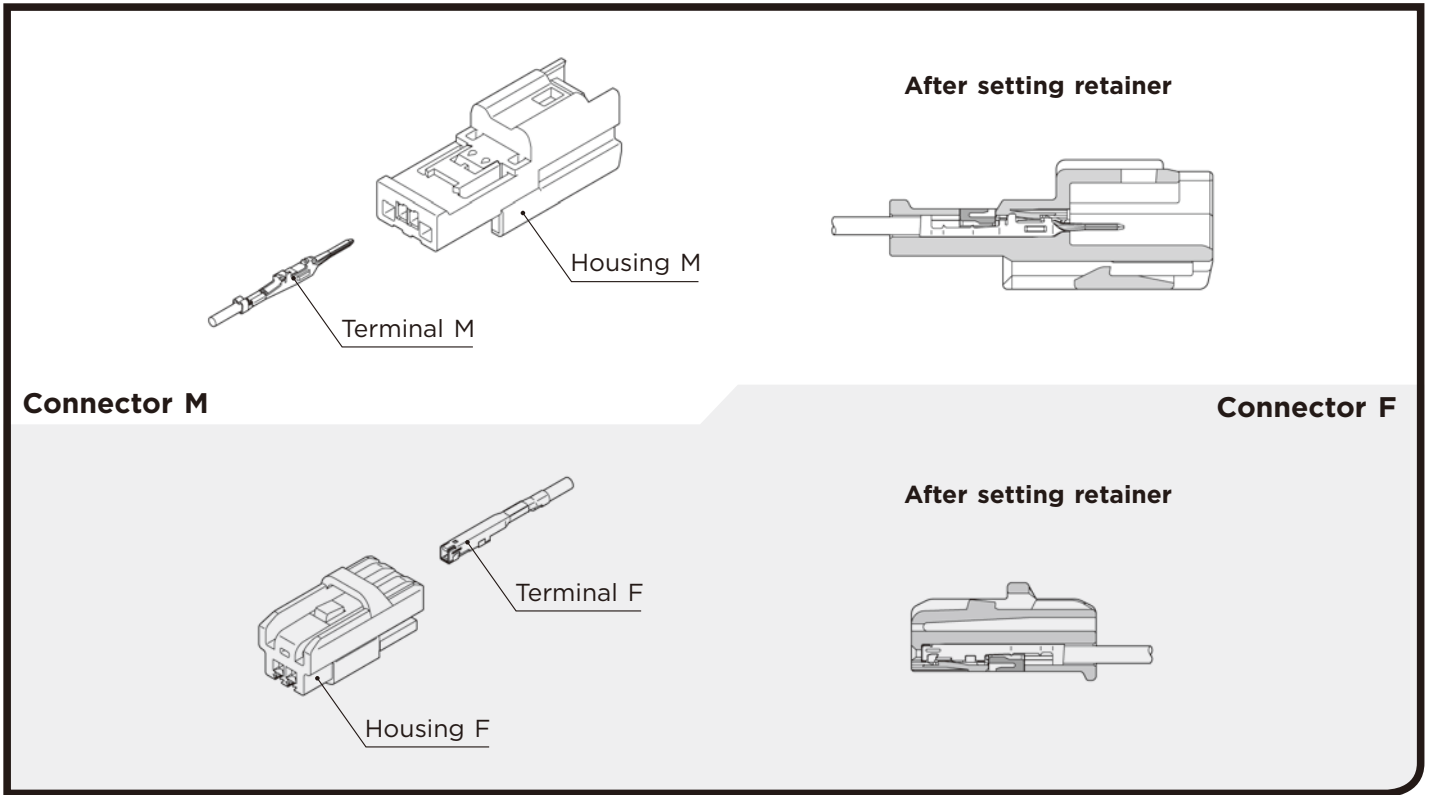

Connector M

Connector F

0.64mm (025)

Terminal (UNIT : mm)

Ref; 0.64mm Terminal detail

S	M(8100-4028)	F(8100-4029)	C-06
M	M(8100-4027)	F(8100-4030)	C-06

0.64mm (025)

Housing (UNIT : mm)

Ref: Terminal part No. C-05

Material PBT

2way

Color Natural

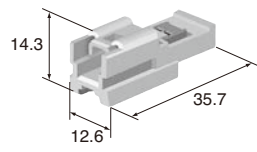

M (6098-4569)

Color Natural

Note with clip for oval hole
回り止めクランプ付

Plate thickness range for clamp;
t=0.6~2.0mm
Hole=7.2mm×10.2mm

M (6098-4567)

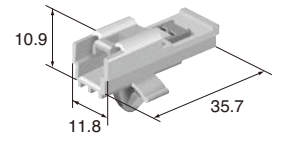

F (6098-4565)

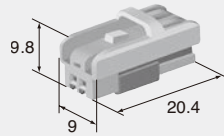

Color

Natural

DL SERIES for STANDARD

1.0mm (040)

This connector has a terminal pitch of 2.5 mm.
端子間ピッチ2.5mmのコネクタです。

Structure

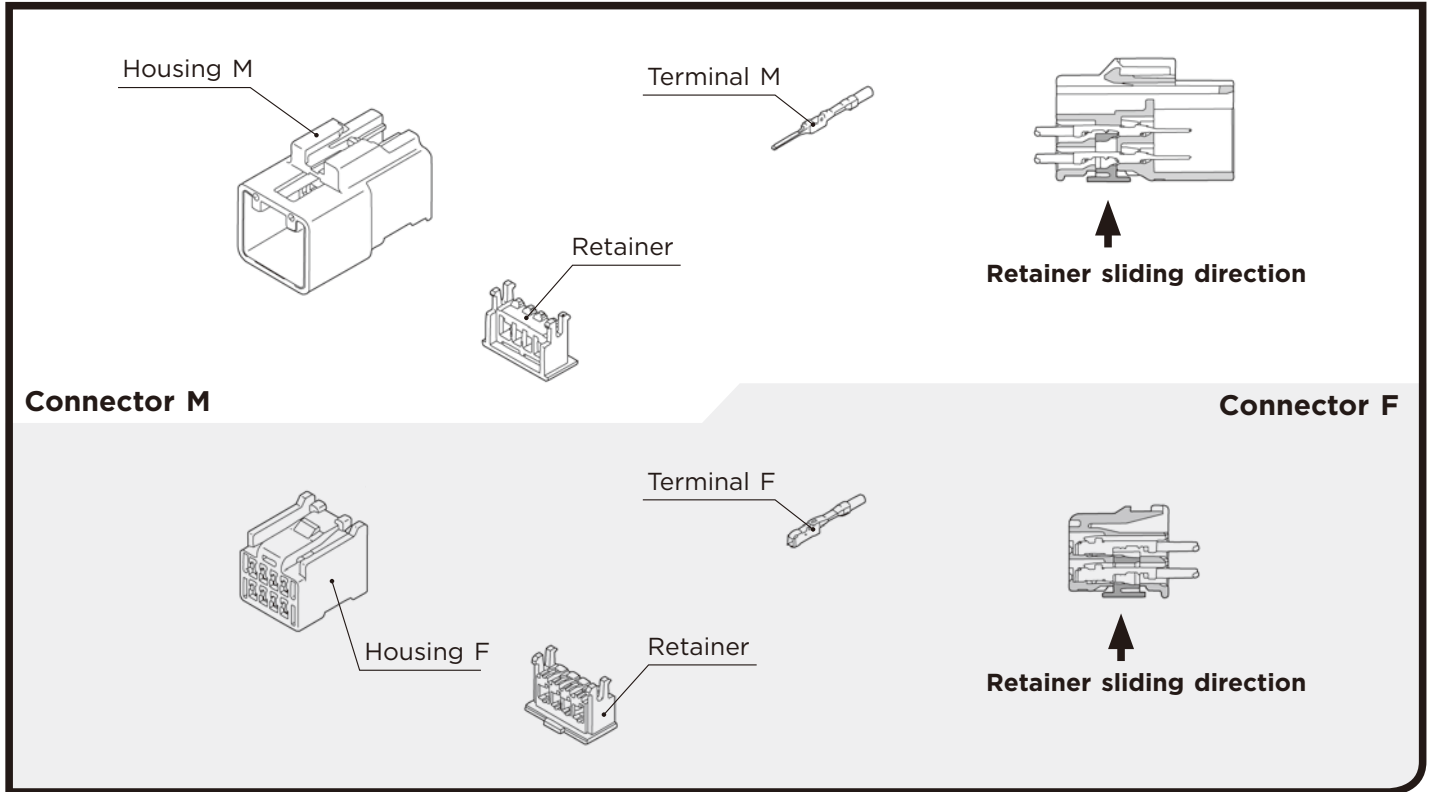

L-04

1.0mm (040)

(E)	(J)
Cable size	: 適用電線サイズ
Cable overall diameter	: 電線仕上り外径
Heat-resistant copper alloy	: 耐熱銅合金
Brass	: 黄銅
Surface treatment	: 表面処理
Gold-plated	: Auメッキ
Tin-plated	: Snメッキ

Terminal (UNIT : mm)

※ For terminal selection, please contact our sales staff.
Note) M size terminal can be used connector with insertion cavity specified. For details, please contact our sales staff.

※ Surface treatment of gold-plated is available to meet your needs.

Thick size is for the time being now.

※ターミナル選定にあたっては、必ず弊社営業担当にお問い合わせください。

注) Mサイズターミナルの使用出来るコネクタは限定されます。必ず弊社営業担当にお問い合わせください。

※ Auメッキ仕様については、必要に応じ設定は可能です。
尚、太物サイズについては、現在の所、暫定とさせていただきます。

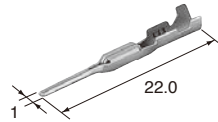
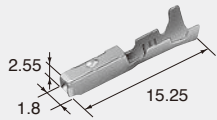
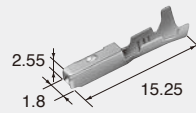
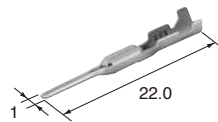
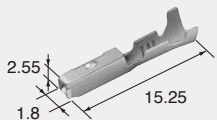
(S)**Cable size (mm²)** 0.3~0.5**Material** Brass**Surface treatment** Tin-plated**M(8100-2512)****F(8100-1710)****Cable size (mm²)** 0.3~0.5**Material** Heat-resistant copper alloy**Surface treatment** Tin-plated**(S)****Au****F(8240-0300)****Cable size (mm²)** 0.3~0.5**Material** Heat-resistant copper alloy**Surface treatment** Gold-plated**(M)****Cable size (mm²)** 0.75, 0.85~1.25**Material** Brass**Surface treatment** Tin-plated**M(8100-2513)****F(8100-2514)****Cable size (mm²)** 0.75, 0.85~1.25**Material** Heat-resistant copper alloy**Surface treatment** Tin-plated**1.0mm(O40)****Housing (UNIT : mm)****Ref: Terminal part No.** L-04**Material** PBT

Note) M size terminal can be used connector with insertion cavity specified. For details, please contact our sales staff.

注) Mサイズターミナルの使用出来るコネクタは限定されます。必ず弊社営業担当にお問い合わせください。

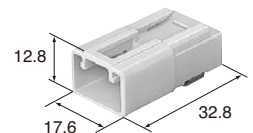
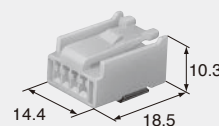
4way**Color** Natural**M(6098-2158)****F(6098-2013)****Color** Natural

8way

Color Natural

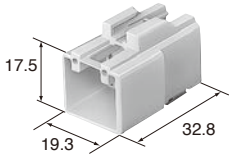

M(6098-2206)

F(6098-2208)

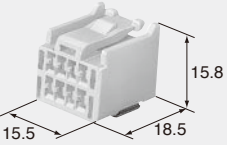

Color Natural

12way

F(6098-2289)

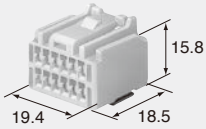

Color Natural

16way

F(6098-1624)

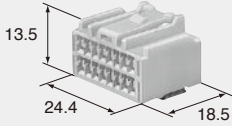

Color Natural

20way

F(6098-1626)

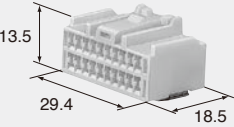

Color Natural

DL SERIES for STANDARD

2.3mm (090)

Structure

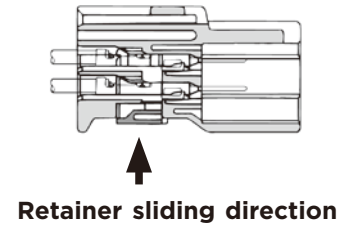
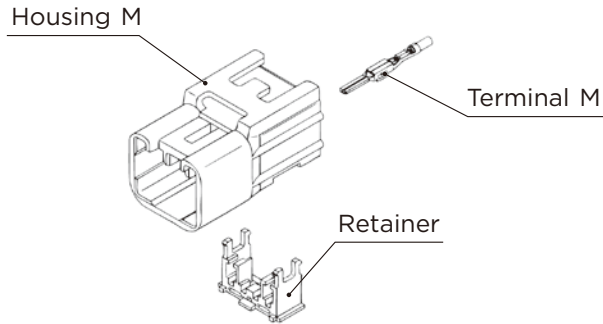

Connector M

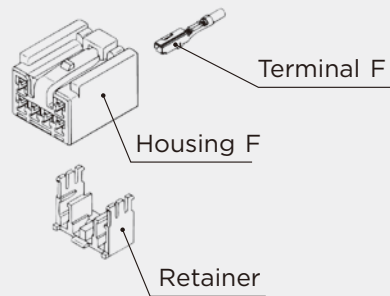

Connector F

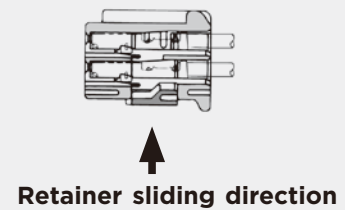

L-07

DL SERIES

2.3mm (090)

Terminal (UNIT : mm)

Ref; 2.3mm Terminal detail

S	M(8230-4492)	F(8240-4882)	A-11
M	M(8230-4502)	F(8240-4892)	A-11
L	M(8230-4512)	F(8240-4942)	A-11

Regarding "Gold-plated Terminal", please refer "A-11".
AuメッキターミナルはA-11ご参照

2.3mm (090)

Housing (UNIT : mm)

Ref: Terminal part No.	A-10
Material	PA6T

2way

Color Natural

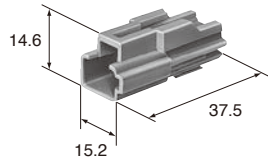

M(6249-1248)

F(6249-1251)

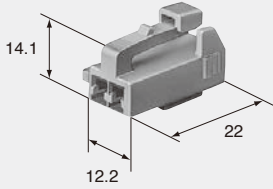

Color Natural

4way

Color Natural

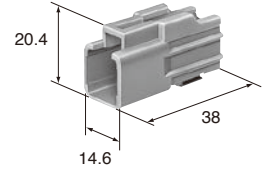

M(6249-1249)

F(6249-1252)

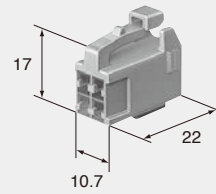

Color Natural

6way

Color Natural

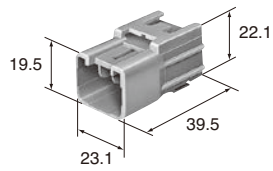

M(6249-1250)

F(6249-1253)

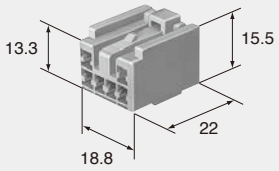

Color Natural

10way

F(6248-5311)

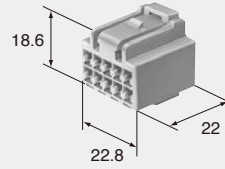

Color Natural

14way

Color Natural

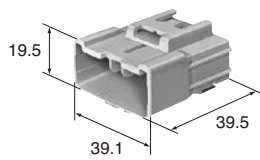

M(6249-1265)

F(6248-5309)

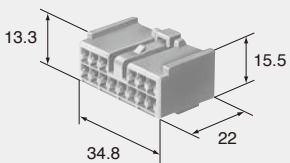

Color Natural

16way

Color Natural

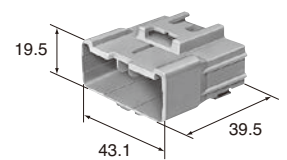

M(6249-1266)

F(6248-5310)

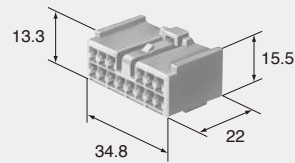

Color Natural

L-08