

# HE SERIES



## Features

The HE connector series is the improved version of the conventional HD series, with a mechanism that minimizes the possibility of terminal back out and semi engagement of connectors.

An incompletely inserted terminal is automatically adjusted to the correct position by setting a TPA/Retainer. A mounting clip or bracket (support) can be attached to the connector housing to secure it to the car body, and multiple connectors can be joined. PCB models are also available for connection to printed circuit boards.

## 特長

HEシリーズは、従来のHDシリーズを改良し、信頼性を向上させたコネクタです。ターミナル抜けやコネクタの半嵌合が起きにくい機構を備えています。

挿入不足のターミナルは、リテーナをセットすることにより正規の位置に固定されます。

コネクタハウジングにはボデーに固定するためのクリップの装着や、コネクタ同士の連結が可能なコネクタもご用意しています。

プリント基板との接続に適したPCBタイプもご用意しています。

# HE SERIES for STANDARD

0.5mm (020)

## Structure

C-02

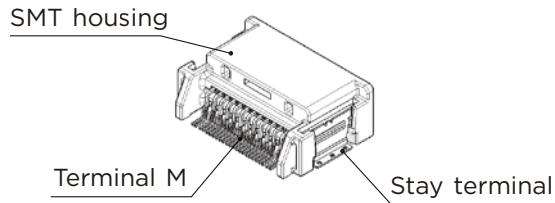

### Connector M (PCB)

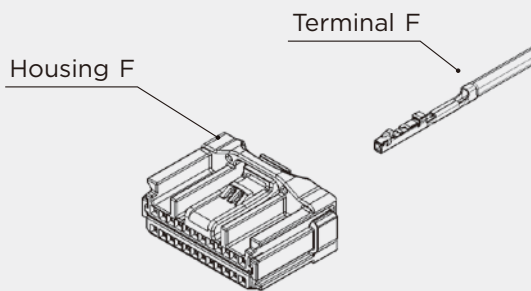

### Connector F

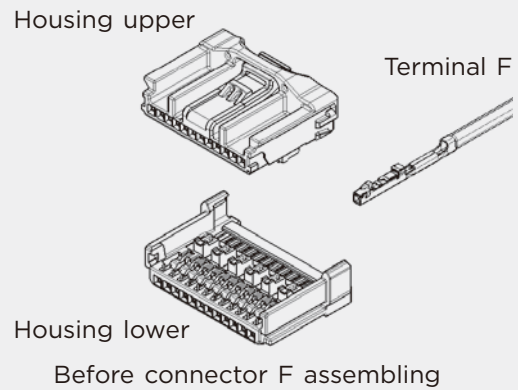

## 0.5mm (020)

(E)	(J)
Cable size	: 適用電線サイズ
Cable overall diameter	: 電線仕上り外径
Heat-resistant copper alloy	: 耐熱銅合金
Brass	: 黄銅
Surface treatment	: 表面処理
Gold-plated	: Auメッキ
Tin-plated	: Snメッキ

## Terminal (UNIT : mm)

(SS)

### F (8240-0700)

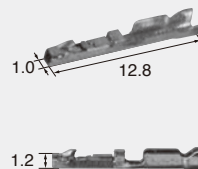

Cable size (mm <sup>2</sup> )	CIVUS0.13
Material	Heat-resistant copper alloy
Surface treatment	Tin-plated

(S)

### F (8240-0701)

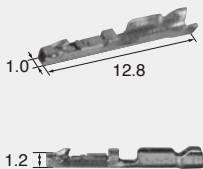

Cable size (mm <sup>2</sup> )	CIVUS0.35
Material	Heat-resistant copper alloy
Surface treatment	Tin-plated

(M)

### F (8240-0702)

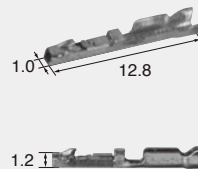

Cable size (mm <sup>2</sup> )	CIVUS0.5
Material	Heat-resistant copper alloy
Surface treatment	Tin-plated

# 0.5mm (020)

## Housing (UNIT : mm)

Ref: Terminal part No. C-02

Material PBT

### 12way

#### F (6099-0063) Upper

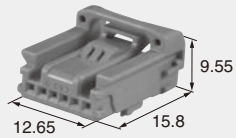

[Reference]  
Upper & Lower  
Completed model

Color Light Gray

#### F (6099-0064) Lower

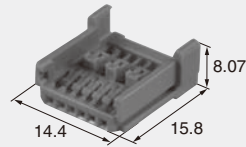

PCB Connector part No.  
6099-0003 (C-04)

Color Light Gray



### 24way

### rib A

#### F (6099-0059) Upper

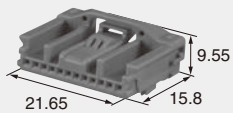

[Reference]  
Upper & Lower  
Completed model

Color Light Gray

#### F (6099-0060) Lower

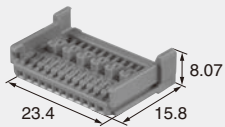

PCB Connector part No.  
6098-9725 (C-04)

Color Light Gray



### 24way

### rib B

#### F (6099-0061) Upper

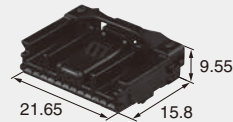

[Reference]  
Upper & Lower  
Completed model

Color Black

#### F (6099-0062) Lower

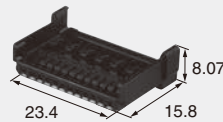

PCB Connector part No.  
6098-9727 (C-04)

Color Black

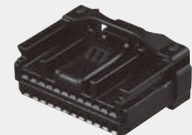

### 42way

#### F (6099-0057) Upper

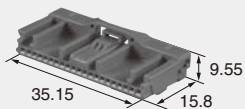

[Reference]  
Upper & Lower  
Completed model

Color Light Gray

#### F (6099-0058) Lower

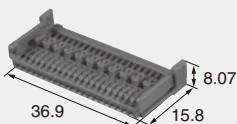

PCB Connector part No.  
6099-0001 (C-04)

Color Light Gray



#### ● Applicable Female Terminal 適用フィメールターミナル一覧

	Lock						Lock													
12Way	B	A	A	A	B		B	A	A	A	A	A	A	A	A	A	A	A	A	B
	B	A	A	A	B		B	A	A	A	A	A	A	A	A	A	A	A	A	B

	Lock																			
42Way	B	A	A	A	A	A	A	A	A	A	A	A	A	A	A	A	A	A	A	B
	B	A	A	A	A	A	A	A	A	A	A	A	A	A	A	A	A	A	A	B

#### ● Applicable Female Terminal for A cavities Aキャビティ適用0.5型端子

サイズ	Alias	適用電線	Applicable Wire	品番	Part.No
SS			CIVU50.13	8240-0700	
S			CIVU50.35	8240-0701	

#### ● Applicable Female Terminal for B cavities Bキャビティ適用0.5型端子

サイズ	Alias	適用電線	Applicable Wire	品番	Part.No
SS			CIVU50.13	8240-0700	
S			CIVU50.35	8240-0701	
M			CIVU50.5	8240-0702	

# HE SERIES for PCB

## 0.5mm (020)

### Housing (UNIT : mm)

Material LCP

**12way (Horizontal SMT)**  
**M (6099-0003)**

Connector F part No. 6099-0063 (C-03)  
6099-0064 (C-03)

Color Gray

**24way (Horizontal SMT) rib A**  
**M (6098-9725)**

Connector F part No. 6099-0059 (C-03)  
6099-0060 (C-03)

Color Gray

**24way (Horizontal SMT) rib B**  
**M (6098-9727)**

Connector F part No. 6099-0061 (C-03)  
6099-0062 (C-03)

Color Black

**42way (Horizontal SMT)**  
**M (6099-0001)**

Connector F part No. 6099-0057 (C-03)  
6099-0058 (C-03)

Color Gray

# HE SERIES for STANDARD

0.64mm (025)

## Structure

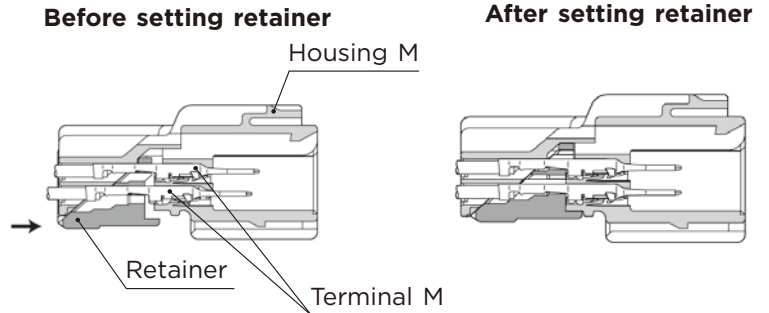
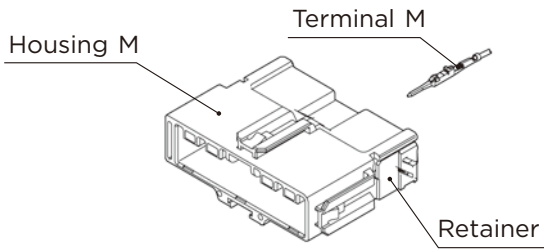

## Connector M

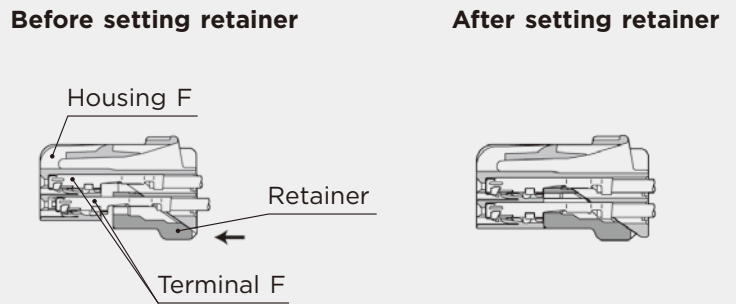
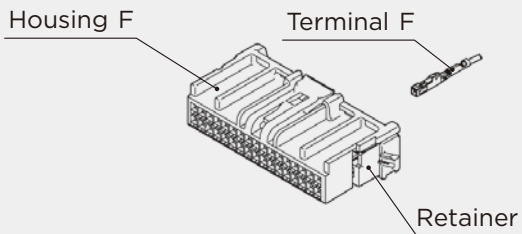

## Connector F

## 0.64mm (025)

(E)	(J)
Cable size	: 適用電線サイズ
Cable overall diameter	: 電線仕上り外径
Heat-resistant copper alloy	: 耐熱銅合金
Brass	: 黄銅
Surface treatment	: 表面処理
Gold-plated	: Auメッキ
Tin-plated	: Snメッキ

## Terminal (UNIT : mm)

C-05

HE SERIES

**(S)**Cable size (mm<sup>2</sup>) 0.22~0.35

Cable overall diameter (mm) 0.95~1.4

Material Brass

Surface treatment Tin-plated

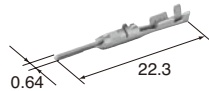
**(M)**Cable size (mm<sup>2</sup>) 0.5~0.75

Cable overall diameter (mm) 1.25~1.6

Material Brass

Surface treatment Tin-plated

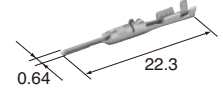
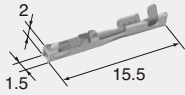
**C-06****M (8100-4028)****F (8100-4029)**Cable size (mm<sup>2</sup>) 0.22~0.35

Cable overall diameter (mm) 0.95~1.4

Material Heat-resistant copper alloy

Surface treatment Tin-plated

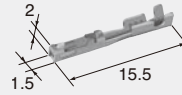
**M (8100-4027)****F (8100-4030)**Cable size (mm<sup>2</sup>) 0.5~0.75

Cable overall diameter (mm) 1.25~1.6

Material Heat-resistant copper alloy

Surface treatment Tin-plated

**0.64mm (025)****Housing** (UNIT : mm)

Ref: Terminal part No. C-05

Material PBT

**2way**

Color Natural

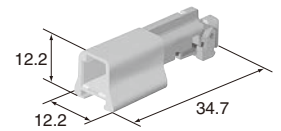
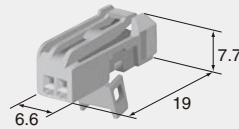
**M (6098-5070)****F (6098-5071)**

Color Natural

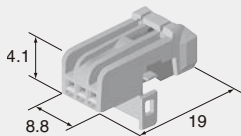
**3way****F (6098-5833)**

Color Natural

**4way**

Color Natural

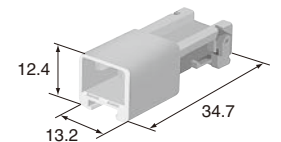
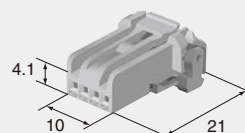
**M (6098-4944)****F (6098-4978)**

Color Natural

**6way**

Color Natural

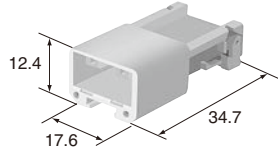

**M (6098-4943)**

**F (6098-4979)**

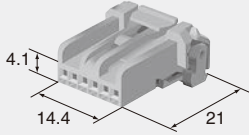

Color Natural

**7way**

**F (6098-5000)**

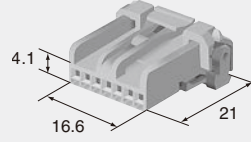

Color Natural

**10way**

**F (6098-4982)**

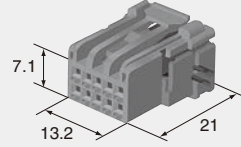

Color Green

**12way**

Color Natural

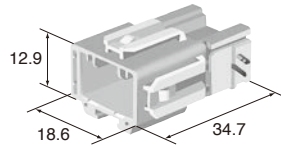

**M (6098-4675)**

**F (6098-4640)**

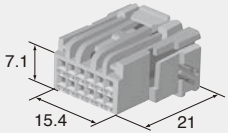

Color Natural

**16way**

Color Natural

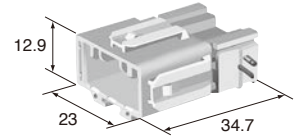

**M (6098-4333)**

**F (6098-4339)**

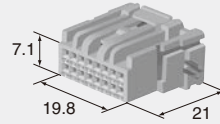

Color Natural

**20way**

Color Natural

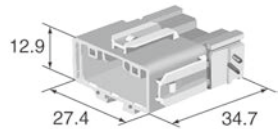

**M (6098-4589)**

**F (6098-4595)**

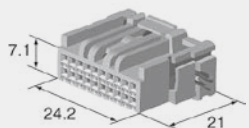

Color Natural

**24way**

Color Natural

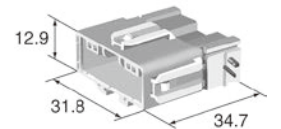

**M (6098-4588)**

**F (6098-4594)**

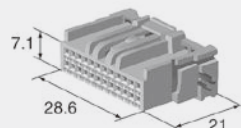

Color Natural

**34way**

**Color** Natural



**C-08**

**M (6098-4590)**

**F (6098-4596)**

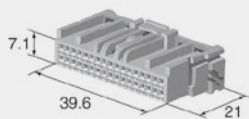

**Color** Natural



# HE SERIES for STANDARD

1.0mm (040)

## Structure

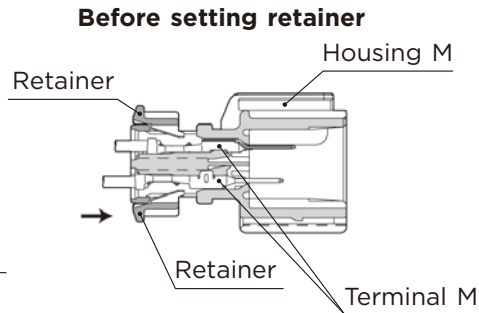
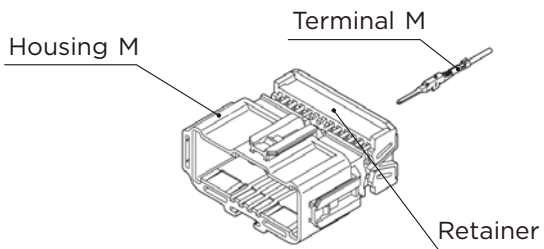

After setting retainer

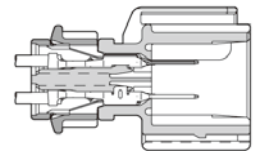

## Connector M

## Connector F

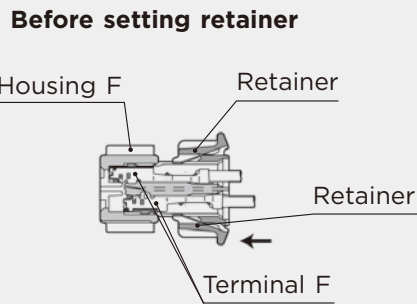
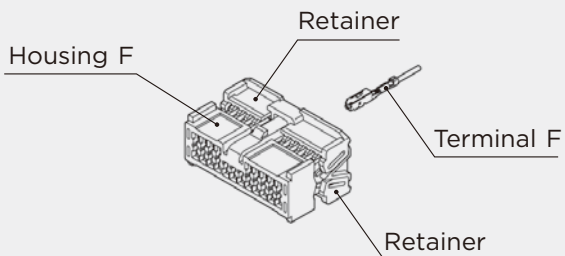

After setting retainer

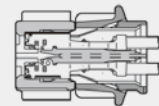

## 1.0mm (040)

(E)	(J)
Cable size	: 適用電線サイズ
Cable overall diameter	: 電線仕上り外径
Heat-resistant copper alloy	: 耐熱銅合金
Brass	: 黄銅
Surface treatment	: 表面処理
Gold-plated	: Auメッキ
Tin-plated	: Snメッキ

## Terminal (UNIT : mm)

**(SS)**Cable size (mm<sup>2</sup>) 0.22~0.35

Cable overall diameter (mm) 0.95~1.1

Material Brass

Surface treatment Tin-plated

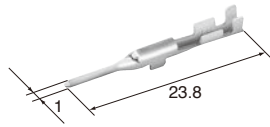
**(S)**Cable size (mm<sup>2</sup>) 0.3~0.85

Cable overall diameter (mm) 1.4~1.8

Material Brass

Surface treatment Tin-plated

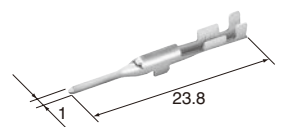
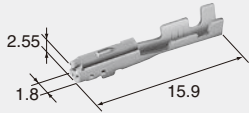
**C-10****M (8100-4307)****F (8100-4308)**Cable size (mm<sup>2</sup>) 0.22~0.35

Cable overall diameter (mm) 0.95~1.1

Material Heat-resistant copper alloy

Surface treatment Tin-plated

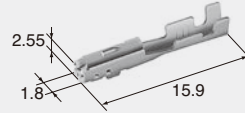
**M (8100-2972)****F (8100-2971)**Cable size (mm<sup>2</sup>) 0.3~0.85

Cable overall diameter (mm) 1.4~1.8

Material Heat-resistant copper alloy

Surface treatment Tin-plated

**1.0mm (040)****Housing** (UNIT : mm)

Ref: Terminal part No. C-09

Material PBT

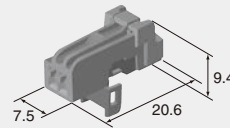
**2way****F (6098-5888)**

Color Light Gray

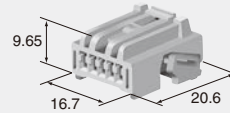
**5way****F (6098-2779)**

Color Natural

**6way**

Color Natural

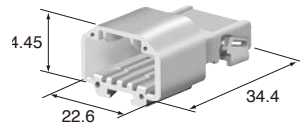
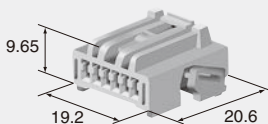
**M (6098-2780)****F (6098-2781)**

Color Natural

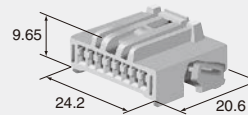
**8way****F (6098-2782)**

Color Natural

**17way**

**Color** Natural

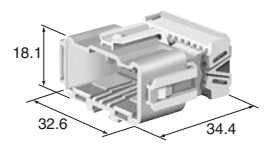

**M (6098-3369)**

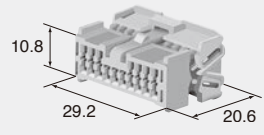

**F (6098-2785)**

**Color** Natural

**13way**

**Color** Natural

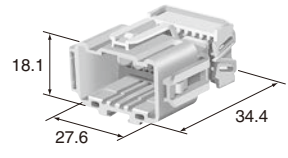

**M (6098-2788)**

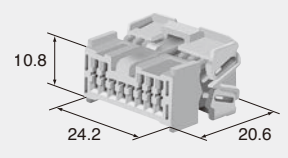

**PCB Connector part No.** 6098-3239 (C-25)

**Color** Natural

**F (6098-2784)**

**21way**

**Color** Natural

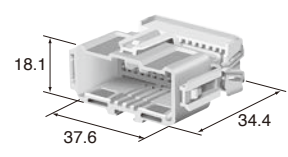

**M (6098-2789)**

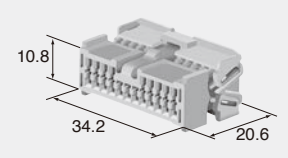

**Color** Natural

**F (6098-2764)**

# HE SERIES for STANDARD

## 2.3mm (090)

### Structure

C-12

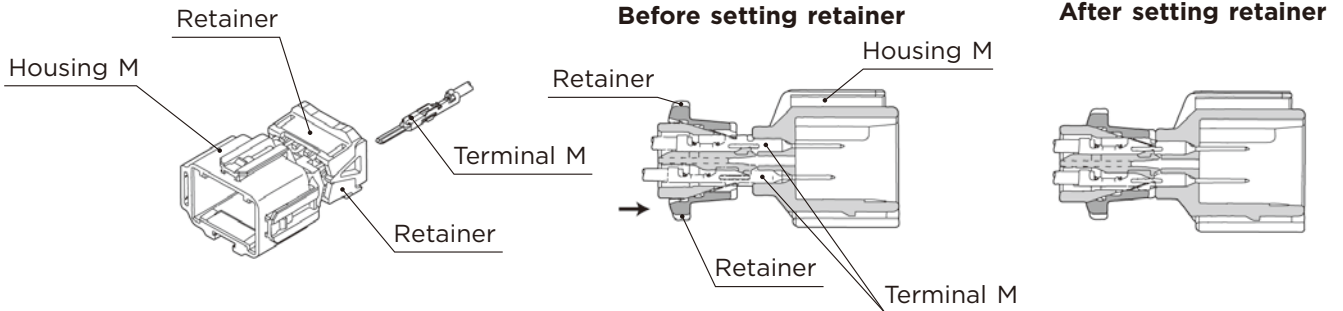

### Connector M

### Connector F

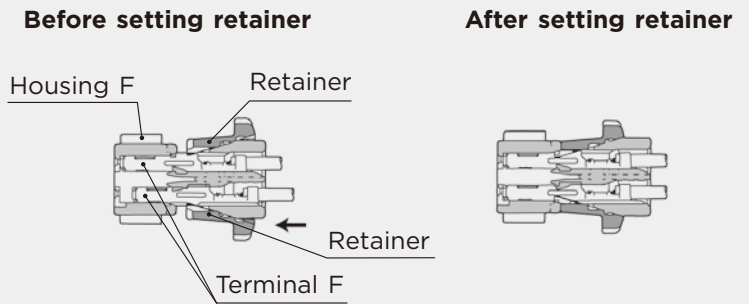
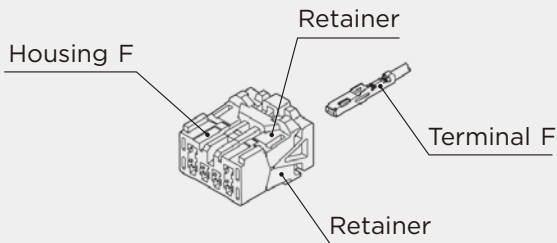

## 2.3mm (090)

(E)	(J)
Cable size	: 適用電線サイズ
Cable overall diameter	: 電線仕上り外径
Heat-resistant copper alloy	: 耐熱銅合金
Brass	: 黄銅
Surface treatment	: 表面処理
Gold-plated	: Auメッキ
Tin-plated	: Snメッキ

## Terminal (UNIT : mm)

(S)

Cable size (mm <sup>2</sup> )	0.3~0.5
Cable overall diameter (mm)	1.4~2.1
Material	Brass
Surface treatment	Tin-plated

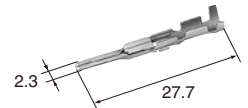

### M (8100-1571)

### F (8100-1470)

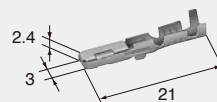

Cable size (mm <sup>2</sup> )	0.3~0.5
Cable overall diameter (mm)	1.4~2.1
Material	Brass
Surface treatment	Tin-plated

**(M)**Cable size (mm<sup>2</sup>) 0.5~1.25

Cable overall diameter (mm) 2.0~2.9

Material Brass

Surface treatment Tin-plated

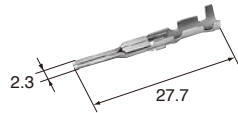
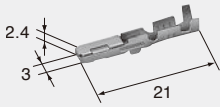
**M (8100-1573)****F (8100-1472)**Cable size (mm<sup>2</sup>) 0.5~1.25

Cable overall diameter (mm) 2.0~2.9

Material Brass

Surface treatment Tin-plated

**(L)**Cable size (mm<sup>2</sup>) 2.0

Cable overall diameter (mm) 2.6~3.1

Material Brass

Surface treatment Tin-plated

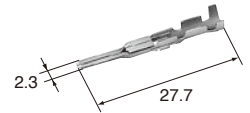
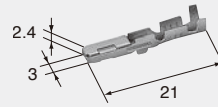
**M (8100-1572)****F (8100-1471)**Cable size (mm<sup>2</sup>) 2.0

Cable overall diameter (mm) 2.6~3.1

Material Heat-resistant copper alloy

Surface treatment Tin-plated

**2.3mm (090)****Housing** (UNIT : mm)

Ref: Terminal part No. C-12

Material PBT

**2way**

Color Natural

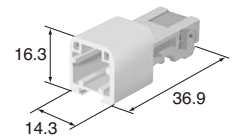
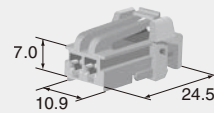
**M (6098-4901)****F (6098-4069)**

Color Natural

**3way**

Color Natural

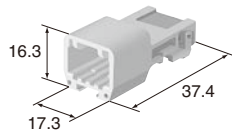
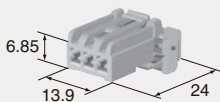
**M (6098-5049)****F (6098-4071)**

Color Natural

**4way**

Color Natural

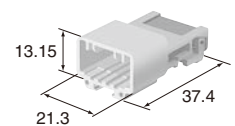
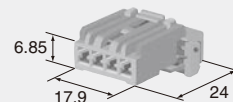
**M (6098-4902)****F (6098-4073)**

Color Natural

**C-13**

HE SERIES

**5way**

Color Natural

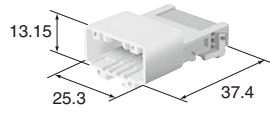

**M (6098-4664)**

**F (6098-4669)**

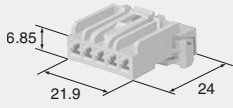

Color Natural

**6way**

Color Sky Blue

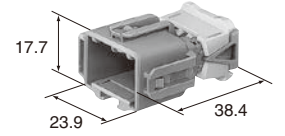

**M (6098-1373)**

**F (6098-1377)**

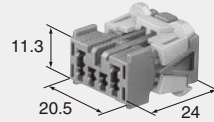

PCB Connector part No. 6098-3616 (C-26)

Color Sky Blue

**8way**

Color Natural

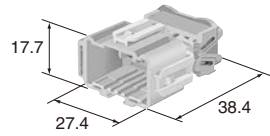

**M (6098-4661)**

**F (6098-4670)**

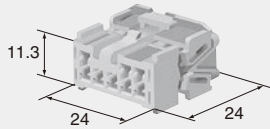

Color Natural

**8way**

**F (6098-1378)**

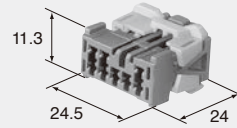

Color Green

**10way**

**F (6240-5378)**

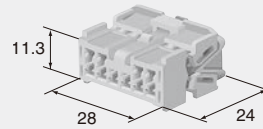

Color Natural

**14way**

Color Natural

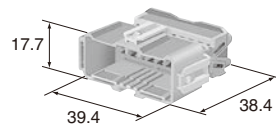

**M (6098-4662)**

**F (6098-4050)**

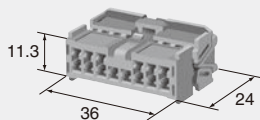

Color Natural

**16way**

**F (6098-3563)**

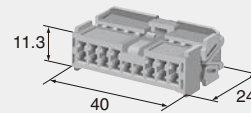

Color Natural

**20way**

**F (6098-1380)**

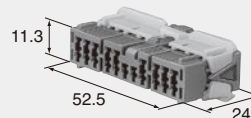

Color Green

C-14

# HE SERIES for STANDARD

4.8mm (187)

C-15

HE SERIES

## 4.8mm (187)

(E)	(J)
Cable size	: 適用電線サイズ
Cable overall diameter	: 電線仕上り外径
Heat-resistant copper alloy	: 耐熱銅合金
Brass	: 黄銅
Surface treatment	: 表面处理
Gold-plated	: Auメッキ
Tin-plated	: Snメッキ

## Terminal (UNIT : mm)

(M)

Cable size (mm<sup>2</sup>) 0.5~1.25

Cable overall diameter (mm) 1.6~2.9

Material Brass

Surface treatment Tin-plated

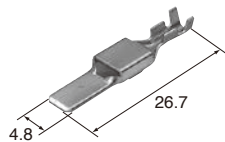

M (8100-0664)

F (8100-0606)

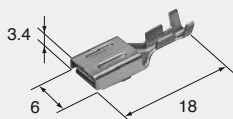

Cable size (mm<sup>2</sup>) 0.5~1.25

Cable overall diameter (mm) 1.6~2.9

Material Heat-resistant copper alloy

Surface treatment Tin-plated

(S)

Cable size (mm<sup>2</sup>) 0.3

Cable overall diameter (mm) 1.4~1.9

Material Brass

Surface treatment Tin-plated

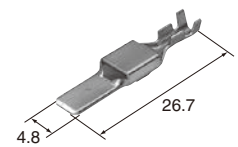

M (8100-1506)

F (8100-1507)

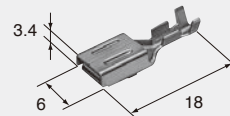

Cable size (mm<sup>2</sup>) 0.3

Cable overall diameter (mm) 1.4~1.9

Material Heat-resistant copper alloy

Surface treatment Tin-plated

(L)

Cable size (mm<sup>2</sup>) 2.0~3.0

Cable overall diameter (mm) 2.6~3.8

Material Brass

Surface treatment Tin-plated

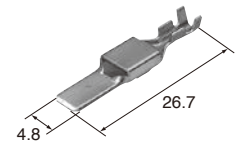

M (1500-0166)

F (8100-0782)

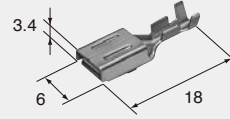

Cable size (mm<sup>2</sup>) 2.0~3.0

Cable overall diameter (mm) 2.6~3.8

Material Heat-resistant copper alloy

Surface treatment Tin-plated

4.8mm (187)

C-16

### Housing (UNIT : mm)

Ref: Terminal part No.	C-15
Material	PBT

### 2way

Color Natural

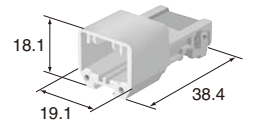

### M (6098-5120) F (6098-5119)

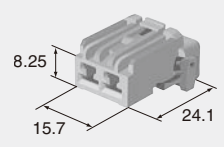

Color Natural

### 4way

### F (6098-4971)

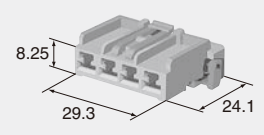

Color Natural

### 5way

Color Natural

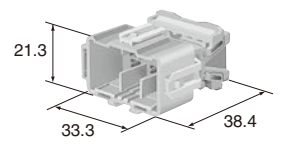

### M (6098-4663) F (6098-4667)

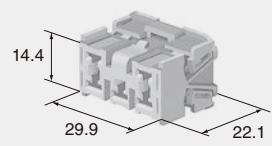

Color Natural



# HE SERIES for STANDARD

9.5mm (375)

C-17

HE SERIES

9.5mm (375)

(E)	(J)
Cable size	: 適用電線サイズ
Cable overall diameter	: 電線仕上り外径
Heat-resistant copper alloy	: 耐熱銅合金
Brass	: 黄銅
Surface treatment	: 表面処理
Gold-plated	: Auメッキ
Tin-plated	: Snメッキ

Terminal (UNIT : mm)

(S)

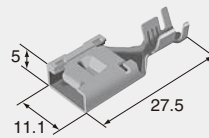

F (8240-0152)

Cable size (mm<sup>2</sup>) 2.0~3.0

Cable overall diameter(mm) 2.6~4.1

Material Brass

Surface treatment Tin-plated

(M)

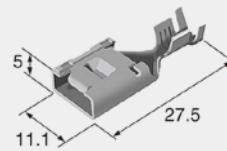

F (8240-0153)

Cable size (mm<sup>2</sup>) 5.0~8.0

Cable overall diameter(mm) 4.4~5.8

Material Heat-resistant copper alloy

Surface treatment Tin-plated

(L)

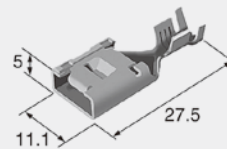

F (8240-0154)

Cable size (mm<sup>2</sup>) 10.0

Cable overall diameter(mm) 6.5~6.9

Material Heat-resistant copper alloy

Surface treatment Tin-plated

9.5mm (375)

Housing (UNIT : mm)

Ref: Terminal part No. C-17

Material PBT

1way

rib A

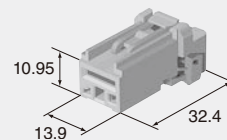

F (6098-4973)

Color Natural

1way

rib B

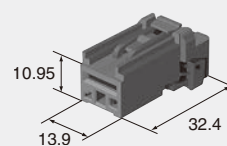

F (6098-4974)

Color Black

1way

rib C

**F (6098-4975)**

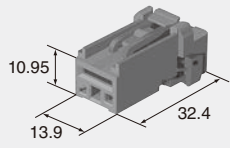

**Color** Dark Green

2way

**F (6098-4977)**

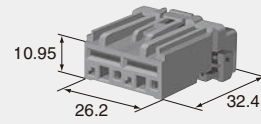

**Color** Green

0.64mm, 2.3mm  
(025, 090)

## Housing (UNIT : mm)

Ref: Terminal part No. [0.64mm] C-05  
[2.3mm] C-12

Material PBT

No. of way/ ( ) corresponds to 0.64mm, 2.3mm, in order from left to right.  
極数 / ( ) 内表示 : 左から0.64mm 極数、2.3mm 極数

C-19

HE SERIES

# HE SERIES for HYBRID

### 12way (6+6)

Color Natural

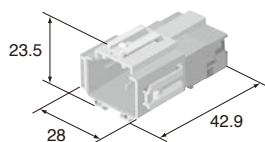

M (6098-6161)

F (6098-6162)

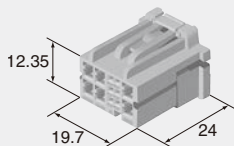

Color Natural

### 13way (9+4)

Color Natural

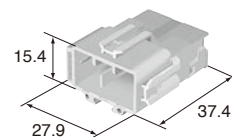

M (6098-5180)

F (6098-6562)

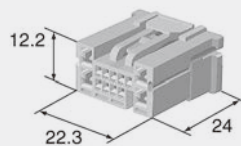

Color Natural

### 18way (9+9)

Color Natural

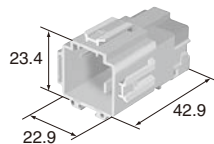

M (6098-4908)

F (6098-6478)

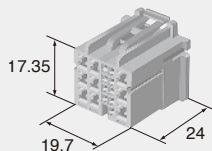

Color Natural

### 20way (16+4)

Color Natural

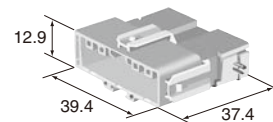

M (6098-4591)

F (6098-4597)

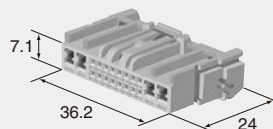

Color Natural

**23way (14+9)**

Color Natural

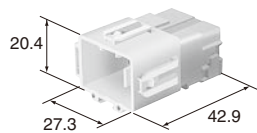

**28way (24+4)**

Color Natural

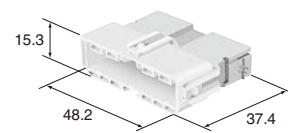

**C-20**

**M (6098-4707)**

**F (6098-6559)**

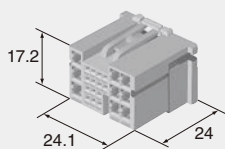

Color Natural

**M (6098-4725)**

**F (6098-4726)**

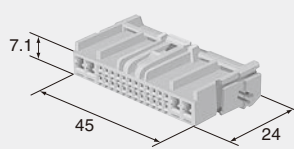

Color Natural

1.0mm, 2.3mm  
(040, 090)

## Housing (UNIT : mm)

Ref: Terminal part No. [1.0mm] C-09  
[2.3mm] C-12

Material PBT

No. of way/ ( ) corresponds to 1.0mm, 2.3mm, in order from left to right.  
極数 / ( ) 内表示: 左から1.0mm 極数、2.3mm 極数

9way (2+7)

F (6098-4075)

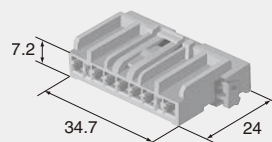

Color Natural

10way (2+8)

F (6098-4076)

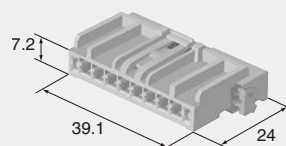

Color Natural

10way (6+4)

F (6098-4666)

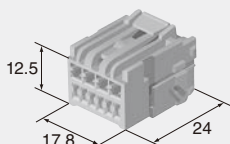

Color Natural

10way (8+2)

F (6098-3600)

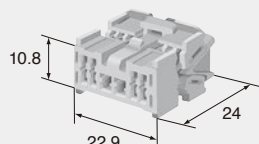

Color Natural

14way (10+4)

F (6098-3601)

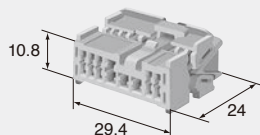

Color Natural

23way (19+4)

F (6098-3571)

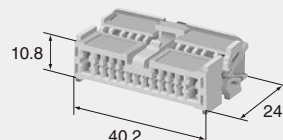

PCB Connector part No. 6098-3572 (C-25)  
Color Natural

23way (19+4)

F (6098-4367)

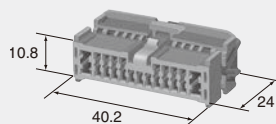

Color Brown

1.0mm, 4.8mm  
(040, 187)

C-22

## Housing (UNIT : mm)

Ref: Terminal part No. [1.0mm] C-09  
[4.8mm] C-15

Material PBT

No. of way/ ( ) corresponds to 1.0mm, 4.8mm, in order from left to right.  
極数 / ( ) 内表示 : 左から1.0mm 極数、4.8mm 極数

### 12way (10+2)

Color Natural

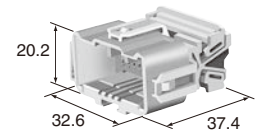

### M (6098-3370)

### F (6098-2786)

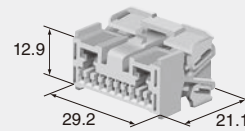

Color Natural

### 14way (10+4)

### F (6098-4017)

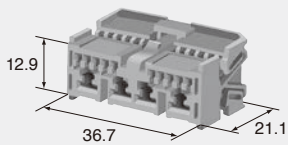

PCB Connector part No. 6098-4018 (C-26)

Color Natural

2.3mm, 4.8mm  
(090, 187)

## Housing (UNIT : mm)

Ref: Terminal part No. [2.3mm] C-12  
[4.8mm] C-15

Material PBT

No. of way/ ( ) corresponds to 2.3mm, 4.8mm, in order from left to right.  
極数 / ( ) 内表示: 左から2.3mm 極数、4.8mm 極数

### 8way (6+2)

Color Natural

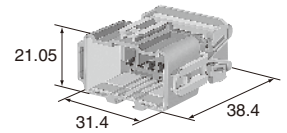

### M (6098-5218)

### F (6098-5217)

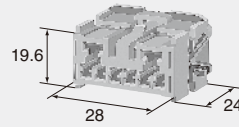

Color Natural

### 14way (12+2)

Color Natural

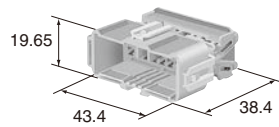

### M (6098-4660)

### F (6098-3565)

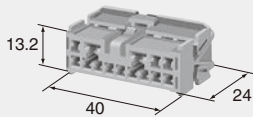

Color Natural

### 16way (14+2)

### F (6950-1054)

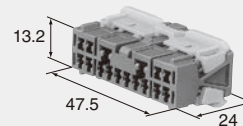

Color Green

### 20way (16+4)

### F (6950-1056)

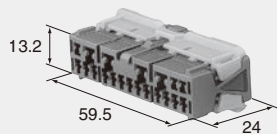

Color Green

## 8.0mm (312)

(E)	(J)
Cable size	: 適用電線サイズ
Cable overall diameter	: 電線仕上り外径
Heat-resistant copper alloy	: 耐熱銅合金
Brass	: 黄銅
Surface treatment	: 表面処理
Gold-plated	: Auメッキ
Tin-plated	: Snメッキ

## Terminal (UNIT : mm)

(M)

Cable size (mm<sup>2</sup>) 2.0~3.0

Cable overall diameter (mm) 2.6~4.1

Material Brass

Surface treatment Tin-plated

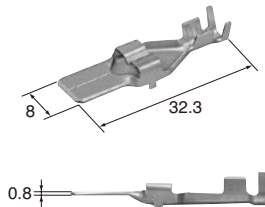

M (8100-0521)

F (8100-0706)

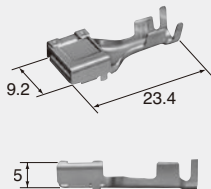

Cable size (mm<sup>2</sup>) 2.0~3.0

Cable overall diameter (mm) 2.6~4.1

Material Brass

Surface treatment Tin-plated

(S)

Cable size (mm<sup>2</sup>) 0.5~1.25

Cable overall diameter (mm) 1.6~2.9

Material Brass

Surface treatment Tin-plated

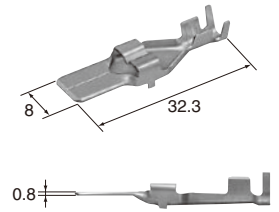

M (8100-0520)

F (8100-0707)

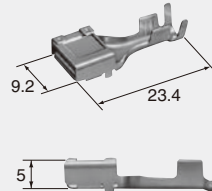

Cable size (mm<sup>2</sup>) 0.5~1.25

Cable overall diameter (mm) 1.6~2.9

Material Brass

Surface treatment Tin-plated

(L)

Cable size (mm<sup>2</sup>) 5.0~8.0

Cable overall diameter (mm) 4.4~5.8

Material Brass

Surface treatment Tin-plated

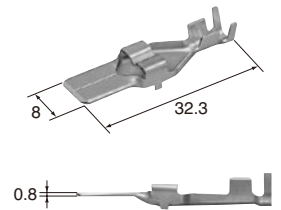

M (8100-0522)

F (8100-1553)

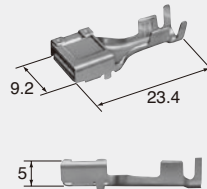

Cable size (mm<sup>2</sup>) 5.0~8.0

Cable overall diameter (mm) 4.4~5.8

Material Heat-resistant copper alloy

Surface treatment Tin-plated

## 4.8mm, 8.0mm (187, 312)

## Housing (UNIT : mm)

Ref: Terminal part No. [4.8mm] C-15  
[8.0mm] C-24

Material PBT

No. of way/ ( ) corresponds to 4.8mm, 8.0mm, in order from left to right.  
極数/ ( ) 内表示: 左から4.8mm 極数、8.0mm 極数

6way (4+2)

F (6098-3569)

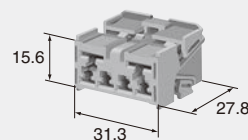

Color Natural







# HE SERIES CONNECTOR ACCESSORIES

## Mounting Clip

The clip can be installed to connector M, if necessary, to fasten into the body side hole.

Mコネクタには、ボデー側の穴に固定するためのクランプを必要に応じて取付けることができます。

### (6810-1203)

Clip fitting hole size(mm)  $\phi 7$

Clip fitting thickness(mm)  $t=0.65\sim 1.6$

Material 6 Nylon

Color Red

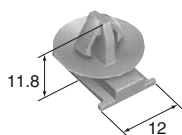

### (6810-1217)

Clip fitting hole size(mm)  $\phi 7$

Clip fitting thickness(mm)  $t=1.6\sim 2.6$

Material 6 Nylon

Color Brown

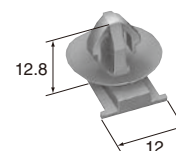

### (6810-1204)

Clip fitting hole size(mm)  $\phi 10$

Clip fitting thickness(mm)  $t=0.65\sim 1.6$

Material 6 Nylon

Color Natural

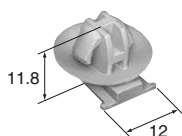

### (6810-1462)

Clip fitting hole size(mm) 6×12 (Square hole)

Clip fitting thickness(mm)  $t=0.65\sim 1.6$

Material 6 Nylon

Color Orange

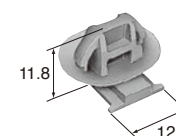

### (6910-0119)

Bracket direction Connector mating direction

Material 6 Nylon

Color Red

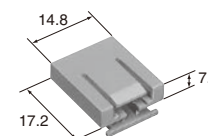

### (6910-0120)

Bracket direction Anti clockwise

Material 6 Nylon

Color Natural

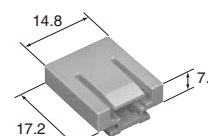

## Bracket (for SP stay)

Connector M can be accoupled with clamp, if necessary, to fasten to the body side bracket.

Mコネクタには、ボデー側のブラケットに固定するためのクランプを必要に応じて取付けることができます。