

HV/HVG SEALED SERIES



Features

The HV sealed connector series is an improved version of the existing HX sealed connector series and it is a highly reliable connector series.

Also, the HVG sealed series is what is added a finger holding portion to the side wall of the female connector of the HV sealed series so as to improving matting performance.

It has a mechanism that detects terminal incomplete insertion.

The connector mechanism only allows the TPA/Retainer to be set when the terminal is completely inserted.

These connectors can be directly secured to a stay on the car body.

特長

HV 防水シリーズは、従来のHX 防水シリーズを改良し、信頼性を向上させたコネクタシリーズです。

また、HVG 防水シリーズは、HV 防水シリーズのFコネクタの側壁に指掛け部を追加し、コネクタ挿入作業性を向上させたものです。

挿入不足のターミナルを検知する機構を備えています。

ターミナルが半挿入の状態では、リテーナが装着できない機構になっています。

コネクタは、ボデー側のステーに直接固定することができます。

HV/HVG SEALED SERIES for STANDARD

1.0mm (040)

Structure

D-02

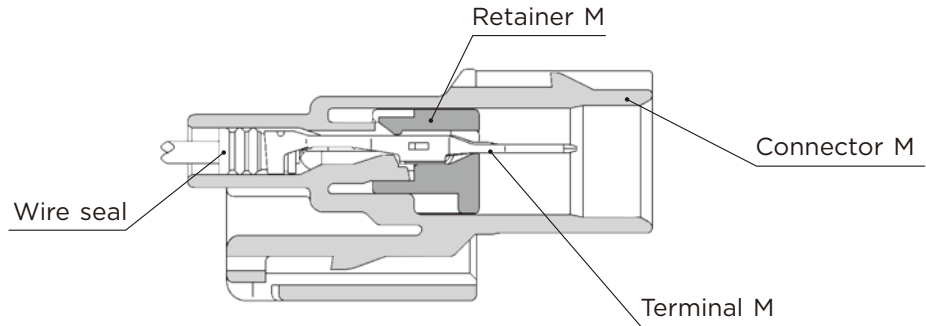

Connector M

Connector F

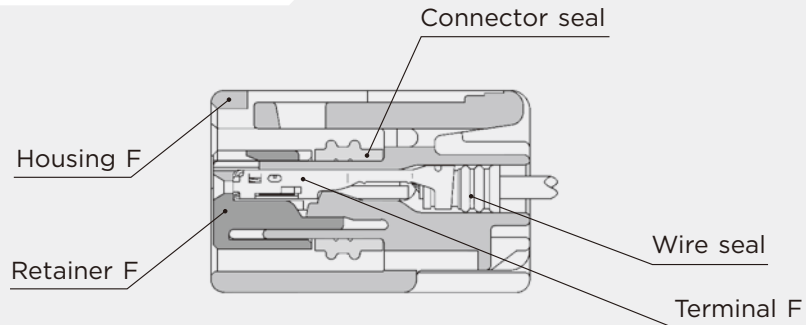

1.0mm (040)

Terminal (UNIT : mm)

Ref; 1.0mm Terminal detail

S	M (8100-3177)	F (8100-3067)	E-03
M	M (8100-3178)	F (8100-3068)	E-03

1.0mm (040)

Wire seals (UNIT : mm)

Ref; 1.0mm Wire Seals detail

SS	(7165-1075)	E-03
S	(7165-0621)	E-03
M	(7165-0622)	E-03

The wire seals are common to M and F.
ワイヤシールは、M、F 共用です。

1.0mm (040)

Dummy plugs (UNIT : mm)

Ref; 1.0mm Dummy plug detail

(7165-0432) E-04

- Dummy plugs are common to M and F.
- Dummy plugs are used to blind unused terminal holes.
- ダミー栓はM、F 共用です。
- 不必要なターミナル穴を塞ぐために、ダミー栓を使用します。

1.0mm (040)

Housing (UNIT : mm)

Ref: Terminal part No. E-02

Ref: wire seal No. E-03

Ref: Dummy plug No. E-04

Material PBT

3way

Color Black

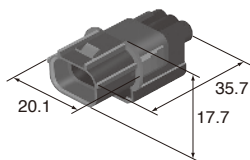

M (6188-4775)

F (6189-7037)

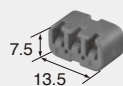
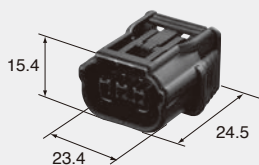

Retainer No. (6918-1833)

Color Black

2way

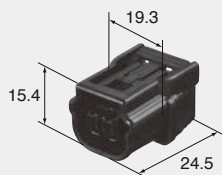

F (6189-7036)

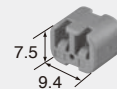

Retainer No. (6918-1835)

Color Black

2way

(Coded connector) (リブ違)

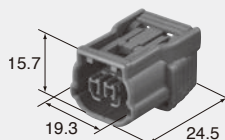

F (6189-7052)



Retainer No. (6918-1835)

Color Dark Gray

3way

(Coded connector) (リブ違)

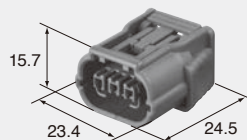

F (6189-7058)

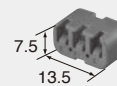

Retainer No. (6918-1833)

Color Dark Gray

4way

Color Black

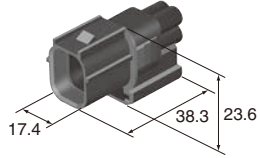

M (6188-4776)

F (6189-7039)

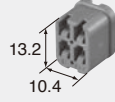
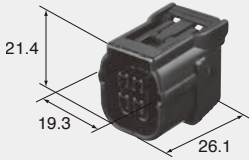

Retainer No. (6918-2810)

Color Black

5way

F (6189-6909)

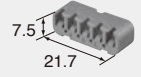
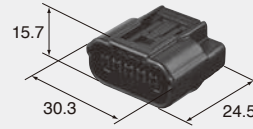

Retainer No. (6918-2128)

Color Black

6way

Color Black

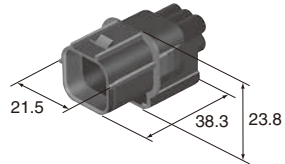

M (6188-4908)

F (6189-7040)

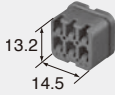
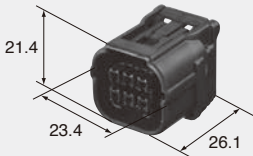

Retainer No. (6918-2913)

Color Black

10way

Color Black

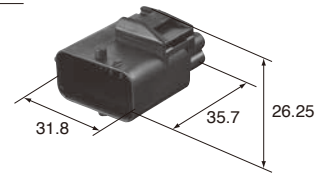
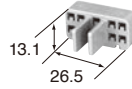

Retainer No. (6918-2804)

M (6181-6481)

F (6189-6906)

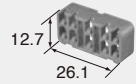
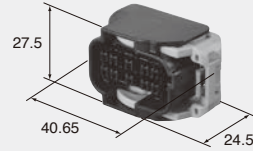

Retainer No. (6918-2806)

Color Black

D-04