

HE SERIES

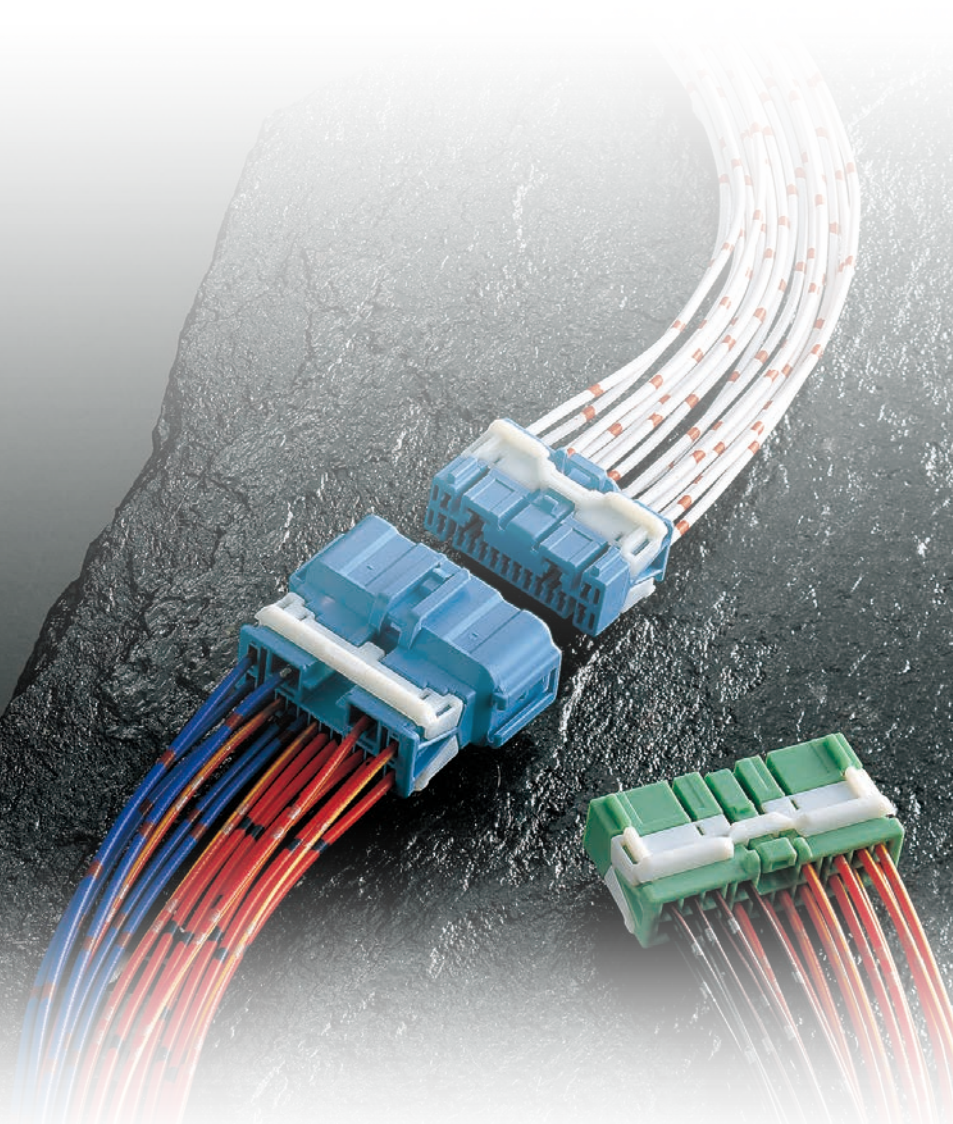

Features

The HE connector series is the improved version of the conventional HD series, with a mechanism that minimizes the possibility of terminal back out and semi engagement of connectors.

An incompletely inserted terminal is automatically adjusted to the correct position by setting a TPA/Retainer. TPA/Retainers are pre-mounted on the connector housing.

A mounting clip or slot clip can be attached to the connector housing to secure it to the car body, and multiple connectors can be joined.

PCB models are also available for connection to printed circuit boards.

特長

HEシリーズは、従来のHDシリーズを改良し、信頼性を向上させたコネクタです。ターミナル抜けやコネクタの半嵌合が起きにくい機構を備えています。

挿入不足のターミナルは、リテーナをセットすることにより正規の位置に固定されます。

リテーナは、コネクタハウジングに予め組み付けられています。

コネクタハウジングにはボデーに固定するためのクリップを装着することができ、更にコネクタ同士の連結が可能です。

プリント基板との接続に適したPCBタイプもご用意しています。

HE SERIES for STANDARD

0.64mm (025)

Structure

C-02

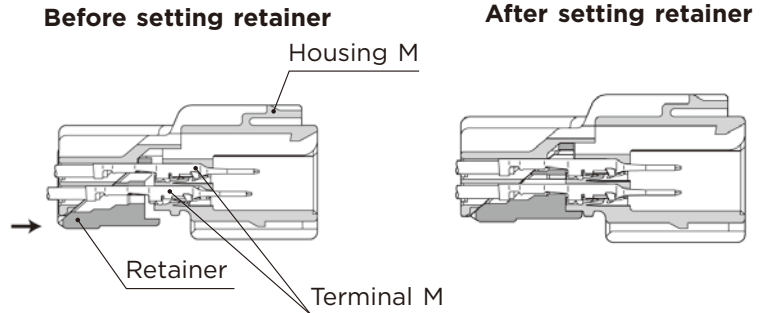
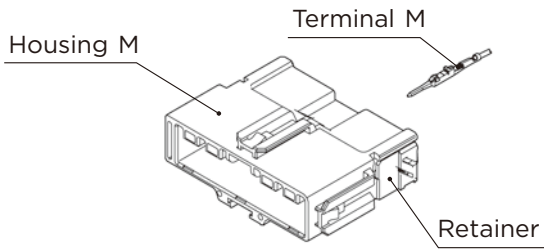

Connector M

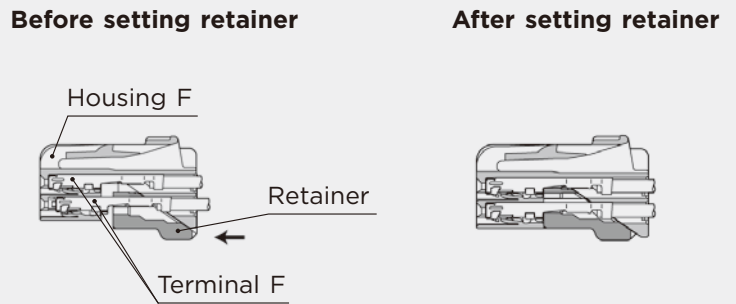
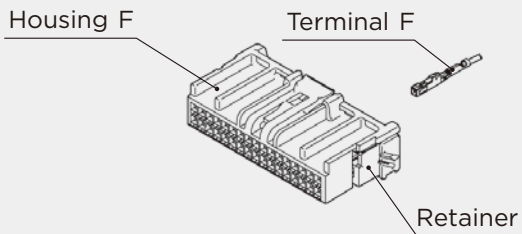

Connector F

0.64mm (025)

(E)	(J)
Cable size	: 適用電線サイズ
Cable overall diameter	: 電線仕上り外径
Heat-resistant copper alloy	: 耐熱銅合金
Brass	: 黄銅
Surface treatment	: 表面処理
Gold-plated	: Auメッキ
Tin-plated	: Snメッキ

Terminal (UNIT : mm)

(S)Cable size (mm²) 0.22~0.35

Cable overall diameter (mm) 0.95~1.4

Material Brass

Surface treatment Tin-plated

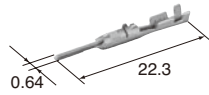
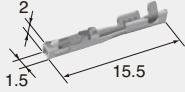
**M (8100-4028)****F (8100-4029)**Cable size (mm²) 0.22~0.35

Cable overall diameter (mm) 0.95~1.4

Material Heat-resistant copper alloy

Surface treatment Tin-plated

(M)Cable size (mm²) 0.5~0.75

Cable overall diameter (mm) 1.25~1.6

Material Brass

Surface treatment Tin-plated

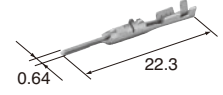
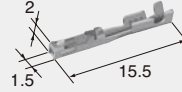
**M (8100-4027)****F (8100-4030)**Cable size (mm²) 0.5~0.75

Cable overall diameter (mm) 1.25~1.6

Material Heat-resistant copper alloy

Surface treatment Tin-plated

0.64mm (025)**Housing** (UNIT : mm)

Ref: Terminal part No. C-02

Material PBT

2way

Color Natural

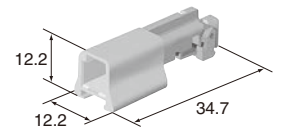
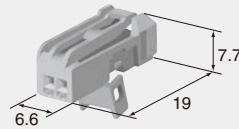
**M (6098-5070)****F (6098-5071)**

Color Natural

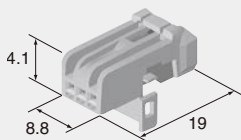
3way**F (6098-5833)**

Color Natural

4way

Color Natural

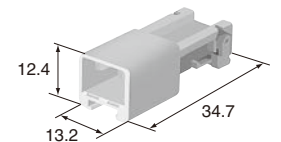
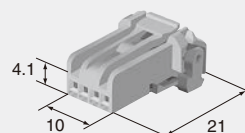
**M (6098-4944)****F (6098-4978)**

Color Natural

C-03

HE SERIES

6way

Color Natural

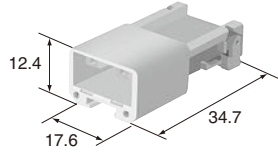

7way

F (6098-5000)

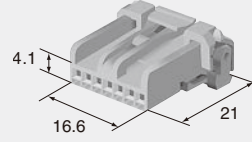

Color Natural

C-04

M (6098-4943)

F (6098-4979)

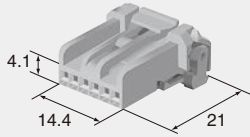

Color Natural

10way

F (6098-4982)

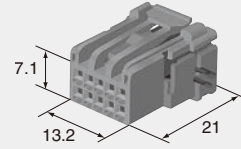

Color Green

12way

Color Natural

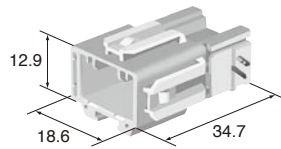

M (6098-4675)

F (6098-4640)

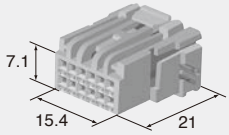

Color Natural

16way

Color Natural

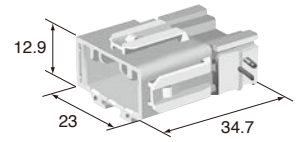

M (6098-4333)

F (6098-4339)

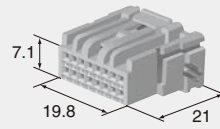

Color Natural

20way

Color Natural

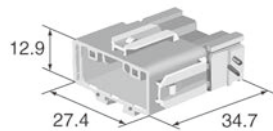

M (6098-4589)

F (6098-4595)

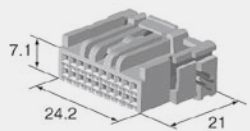

Color Natural

24way

Color Natural

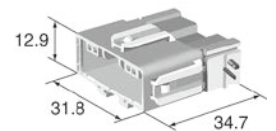

M (6098-4588)

F (6098-4594)

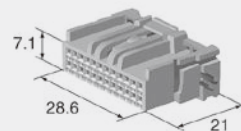

Color Natural

34way

Color Natural

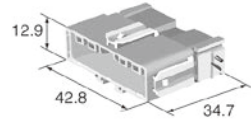

M (6098-4590)

F (6098-4596)

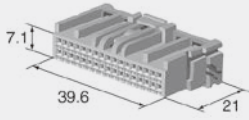

Color Natural

HE SERIES for STANDARD

1.0mm (040)

Structure

C-06

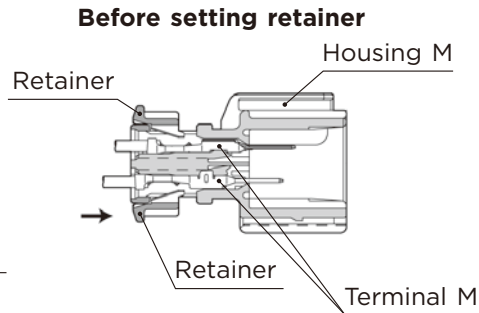
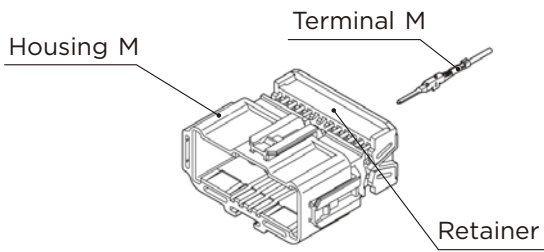

After setting retainer

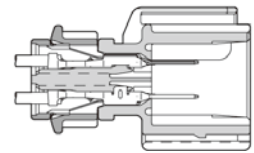

Connector M

Connector F

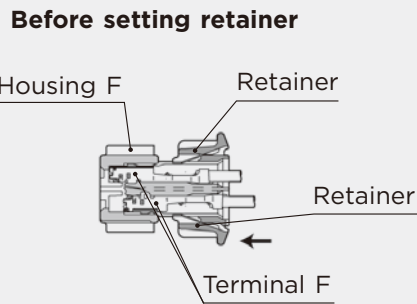
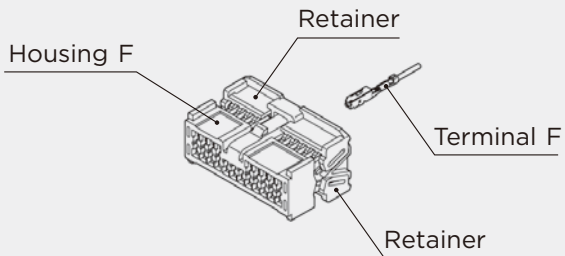

After setting retainer

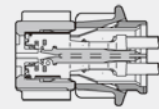

1.0mm (040)

(E)	(J)
Cable size	: 適用電線サイズ
Cable overall diameter	: 電線仕上り外径
Heat-resistant copper alloy	: 耐熱銅合金
Brass	: 黄銅
Surface treatment	: 表面処理
Gold-plated	: Auメッキ
Tin-plated	: Snメッキ

Terminal (UNIT : mm)

(SS)Cable size (mm²) 0.22~0.35

Cable overall diameter(mm) 0.95~1.1

Material Brass

Surface treatment Tin-plated

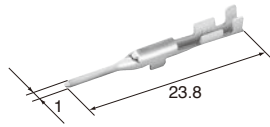
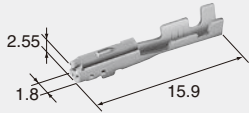
**M (8100-4307)****F (8100-4308)**Cable size (mm²) 0.22~0.35

Cable overall diameter(mm) 0.95~1.1

Material Heat-resistant copper alloy

Surface treatment Tin-plated

(S)Cable size (mm²) 0.3~0.85

Cable overall diameter(mm) 1.4~1.8

Material Brass

Surface treatment Tin-plated

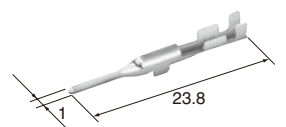
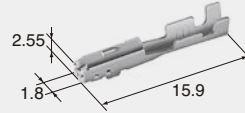
**M (8100-2972)****F (8100-2971)**Cable size (mm²) 0.3~0.85

Cable overall diameter(mm) 1.4~1.8

Material Heat-resistant copper alloy

Surface treatment Tin-plated

1.0mm (040)**Housing** (UNIT : mm)

Ref: Terminal part No. C-06

Material PBT

6way

Color Natural

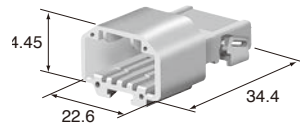
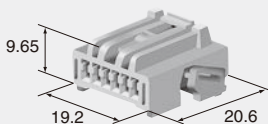
**M (6098-2780)****F (6098-2781)**

Color Natural

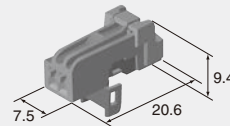
2way**F (6098-5888)**

Color Light Gray

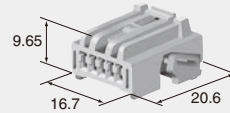
5way**F (6098-2779)**

Color Natural

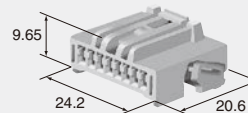
8way**F (6098-2782)**

Color Natural

C-07

HE SERIES

C-08

13way

Color Natural

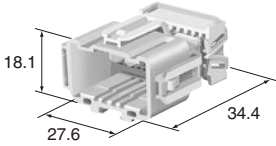

M (6098-2788)

F (6098-2784)

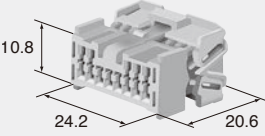

PCB Connector part No. 6098-3239 (C-22)

Color Natural

21way

Color Natural

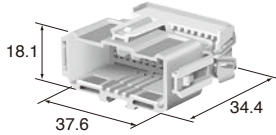

M (6098-2789)

F (6098-2764)

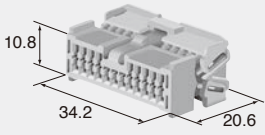

Color Natural

17way

Color Natural

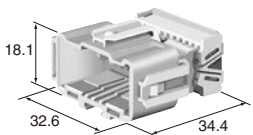

M (6098-3369)

F (6098-2785)

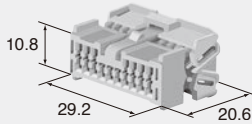

Color Natural

HE SERIES for STANDARD

2.3mm (090)

Structure

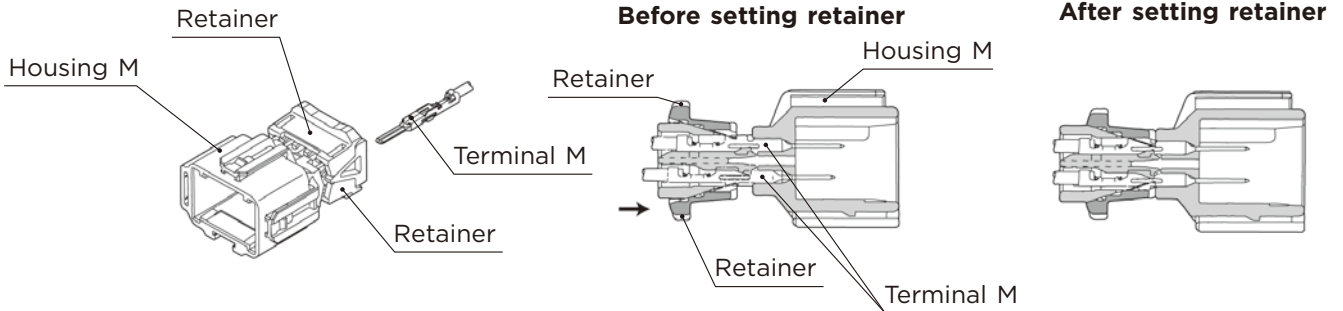

Connector M

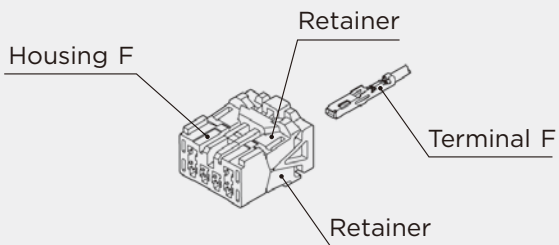

Connector F

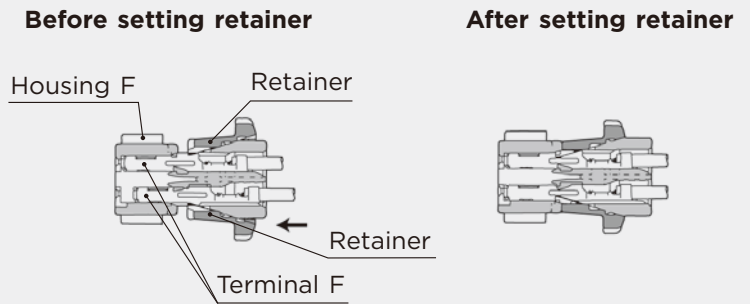

2.3mm (090)

(E)	(J)
Cable size	: 適用電線サイズ
Cable overall diameter	: 電線仕上り外径
Heat-resistant copper alloy	: 耐熱銅合金
Brass	: 黄銅
Surface treatment	: 表面処理
Gold-plated	: Auメッキ
Tin-plated	: Snメッキ

Terminal (UNIT : mm)

(S)

Cable size (mm ²)	0.3~0.5
Cable overall diameter (mm)	1.4~2.1
Material	Brass
Surface treatment	Tin-plated

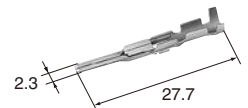

M (8100-1571)

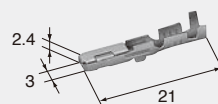

Cable size (mm ²)	0.3~0.5
Cable overall diameter (mm)	1.4~2.1
Material	Brass
Surface treatment	Tin-plated

F (8100-1470)

(M)Cable size (mm²) 0.5~1.25

Cable overall diameter(mm) 2.0~2.9

Material Brass

Surface treatment Tin-plated

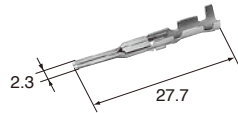
**(L)**Cable size (mm²) 2.0

Cable overall diameter(mm) 2.6~3.1

Material Brass

Surface treatment Tin-plated

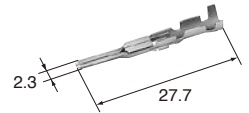
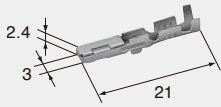
**C-10****M (8100-1573)****F (8100-1472)**Cable size (mm²) 0.5~1.25

Cable overall diameter(mm) 2.0~2.9

Material Brass

Surface treatment Tin-plated

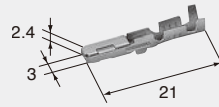
M (8100-1572)**F (8100-1471)**Cable size (mm²) 2.0

Cable overall diameter(mm) 2.6~3.1

Material Heat-resistant copper alloy

Surface treatment Tin-plated

2.3mm (090)**Housing** (UNIT : mm)

Ref: Terminal part No. C-09

Material PBT

2way

Color Natural

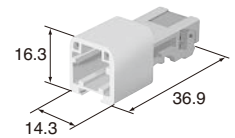
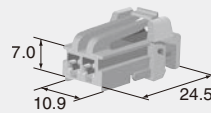
**M (6098-4901)****F (6098-4069)**

Color Natural

3way

Color Natural

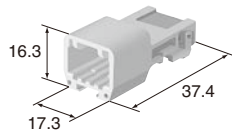
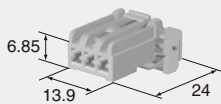
**M (6098-5049)****F (6098-4071)**

Color Natural

4way

Color Natural

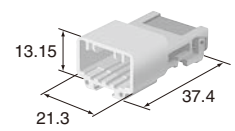
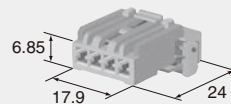
**M (6098-4902)****F (6098-4073)**

Color Natural

6way

Color Sky Blue

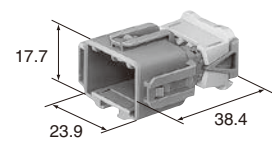

M (6098-1373) **F (6098-1377)**

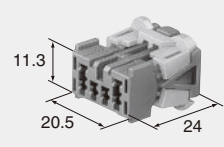

PCB Connector part No. 6098-3616 (C-23)
Color Sky Blue

5way

Color Natural

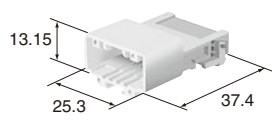

M (6098-4664) **F (6098-4669)**

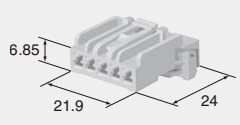

Color Natural

8way

F (6098-1378)

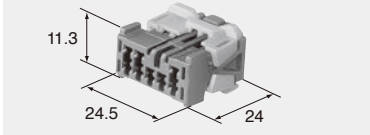

Color Green

8way

Color Natural

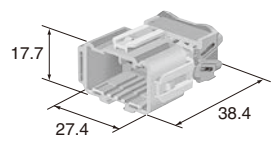

M (6098-4661) **F (6098-4670)**

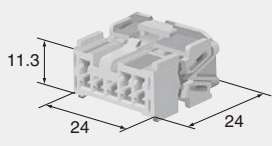

Color Natural

10way

F (6240-5378)

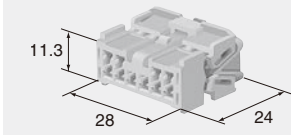

Color Natural

14way

Color Natural

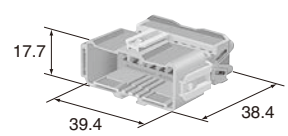

M (6098-4662) **F (6098-4050)**

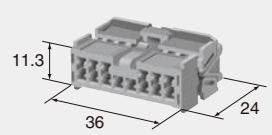

Color Natural

16way

F (6098-3563)

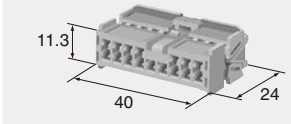

Color Natural

20way

F (6098-1380)

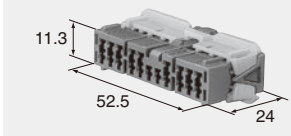

Color Green

HE SERIES for STANDARD

4.8mm (187)

C-12

4.8mm (187)

(E)	(J)
Cable size	: 適用電線サイズ
Cable overall diameter	: 電線仕上り外径
Heat-resistant copper alloy	: 耐熱銅合金
Brass	: 黄銅
Surface treatment	: 表面处理
Gold-plated	: Auメッキ
Tin-plated	: Snメッキ

Terminal (UNIT : mm)

(M)

Cable size (mm²)	0.5~1.25
Cable overall diameter (mm)	1.6~2.9
Material	Brass
Surface treatment	Tin-plated

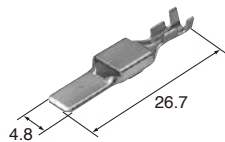

M (8100-0664)

F (8100-0606)

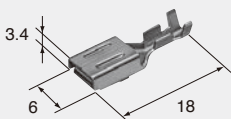

Cable size (mm²)	0.5~1.25
Cable overall diameter (mm)	1.6~2.9
Material	Heat-resistant copper alloy
Surface treatment	Tin-plated

(S)

Cable size (mm²)	0.3
Cable overall diameter (mm)	1.4~1.9
Material	Brass
Surface treatment	Tin-plated

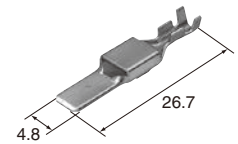

M (8100-1506)

F (8100-1507)

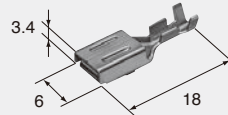

Cable size (mm²)	0.3
Cable overall diameter (mm)	1.4~1.9
Material	Heat-resistant copper alloy
Surface treatment	Tin-plated

(L)

Cable size (mm²)	2.0~3.0
Cable overall diameter (mm)	2.6~3.8
Material	Brass
Surface treatment	Tin-plated

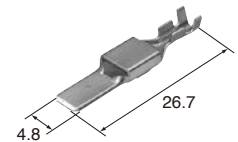

M (1500-0166)

F (8100-0782)

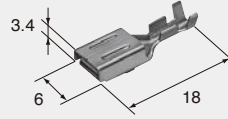

Cable size (mm²)	2.0~3.0
Cable overall diameter (mm)	2.6~3.8
Material	Heat-resistant copper alloy
Surface treatment	Tin-plated

4.8mm (187)

Housing (UNIT : mm)

Ref: Terminal part No. C-12

Material PBT

2way

Color Natural

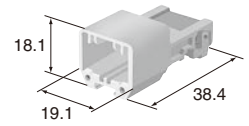

M (6098-5120)

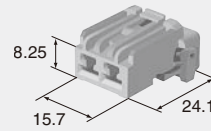

F (6098-5119)

Color Natural

4way

F (6098-4971)

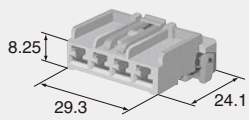

Color Natural

5way

Color Natural

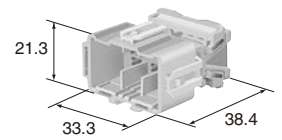

M (6098-4663)

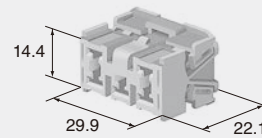

F (6098-4667)

Color Natural

C-13

HE SERIES

HE SERIES for STANDARD

9.5mm (375)

C-14

9.5mm (375)

(E)	(J)
Cable size	: 適用電線サイズ
Cable overall diameter	: 電線仕上り外径
Heat-resistant copper alloy	: 耐熱銅合金
Brass	: 黄銅
Surface treatment	: 表面処理
Gold-plated	: Auメッキ
Tin-plated	: Snメッキ

Terminal (UNIT : mm)

(S)

F (8240-0152)

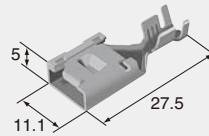

Cable size (mm²) 2.0~3.0

Cable overall diameter (mm) 2.6~4.1

Material Brass

Surface treatment Tin-plated

(M)

F (8240-0153)

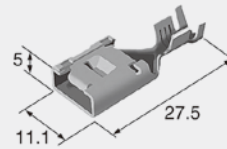

Cable size (mm²) 5.0~8.0

Cable overall diameter (mm) 4.4~5.8

Material Heat-resistant copper alloy

Surface treatment Tin-plated

(L)

F (8240-0154)

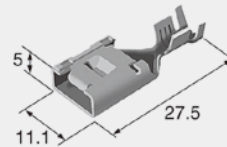

Cable size (mm²) 10.0

Cable overall diameter (mm) 6.5~6.9

Material Heat-resistant copper alloy

Surface treatment Tin-plated

9.5mm (375)

Housing (UNIT : mm)

Ref: Terminal part No. C-14

Material PBT

1way

rib A

F (6098-4973)

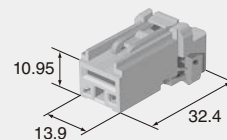

Color Natural

1way

rib B

F (6098-4974)

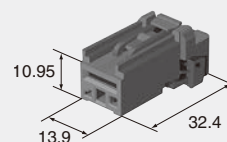

Color Black

1way

rib C

F (6098-4975)

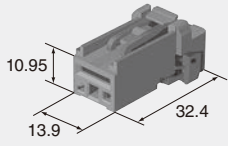

Color Dark Green

2way

F (6098-4977)

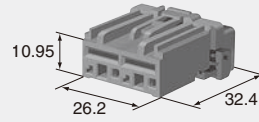

Color Green

C-15

HE SERIES

HE SERIES for HYBRID

0.64mm, 2.3mm
(025, 090)

Housing (UNIT : mm)

Ref: Terminal part No. [0.64mm] C-02
[2.3mm] C-09

Material PBT

No. of way/ () corresponds to 0.64mm, 2.3mm, in order from left to right.
極数 / () 内表示 : 左から0.64mm 極数、2.3mm 極数

12way (6+6)

Color Natural

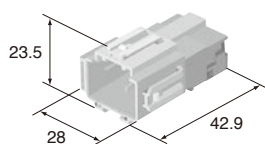

M (6098-6161)

F (6098-6162)

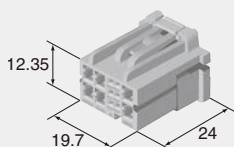

Color Natural

13way (9+4)

Color Natural

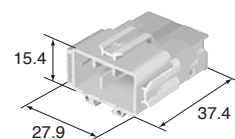

M (6098-5180)

F (6098-6562)

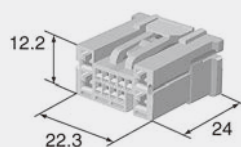

Color Natural

18way (9+9)

Color Natural

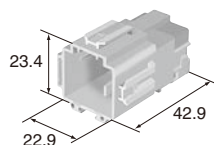

M (6098-4908)

F (6098-6478)

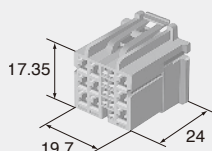

Color Natural

20way (16+4)

Color Natural

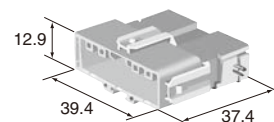

M (6098-4591)

F (6098-4597)

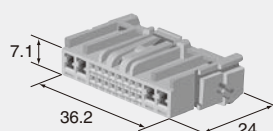

Color Natural

23way (14+9)

Color Natural

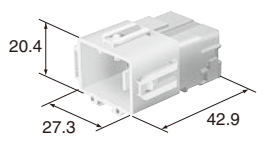

28way (24+4)

Color Natural

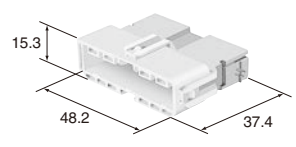

M (6098-4707) F (6098-6559)

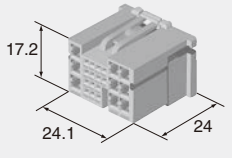

Color Natural

M (6098-4725) F (6098-4726)

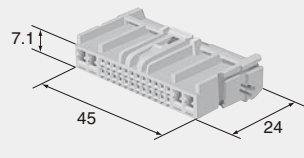

Color Natural

C-17

HE SERIES

1.0mm, 2.3mm (040, 090)

Housing (UNIT : mm)

Ref: Terminal part No. [1.0mm] C-06
[2.3mm] C-09

Material PBT

No. of way/ () corresponds to 1.0mm, 2.3mm, in order from left to right.
極数 / () 内表示: 左から1.0mm 極数、2.3mm 極数

9way (2+7)

F (6098-4075)

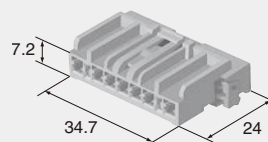

Color Natural

10way (2+8)

F (6098-4076)

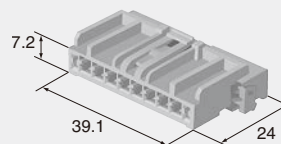

Color Natural

10way (6+4)

F (6098-4666)

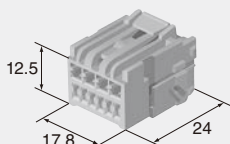

Color Natural

10way (8+2)

F (6098-3600)

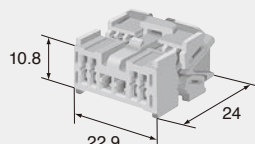

Color Natural

14way (10+4)

F (6098-3601)

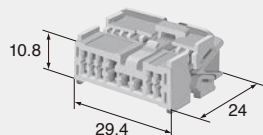

Color Natural

23way (19+4)

F (6098-3571)

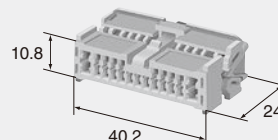

PCB Connector part No. 6098-3572 (C-22)
Color Natural

23way (19+4)

F (6098-4367)

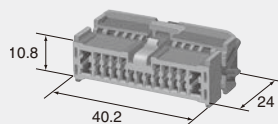

Color Brown

1.0mm, 4.8mm
(040, 187)

Housing (UNIT : mm)

Ref: Terminal part No.	[1.0mm]	C-06
	[4.8mm]	C-12

Material	PBT
----------	-----

No. of way/ () corresponds to 1.0mm, 4.8mm, in order from left to right.
極数 / () 内表示 : 左から1.0mm 極数、4.8mm 極数

12way (10+2)

Color	Natural
-------	---------

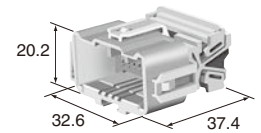

M (6098-3370)

F (6098-2786)

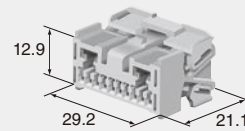

Color	Natural
-------	---------

14way (10+4)

F (6098-4017)

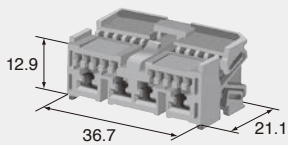

PCB Connector part No.	6098-4018 (C-23)
------------------------	------------------

Color	Natural
-------	---------

2.3mm, 4.8mm (090, 187)

C-20

Housing (UNIT : mm)

Ref: Terminal part No. [2.3mm] C-09
[4.8mm] C-12

Material PBT

No. of way/ () corresponds to 2.3mm, 4.8mm, in order from left to right.
極数 / () 内表示: 左から2.3mm 極数、4.8mm 極数

8way (6+2)

Color Natural

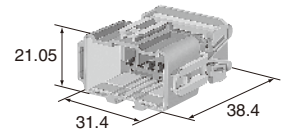

M (6098-5218)

F (6098-5217)

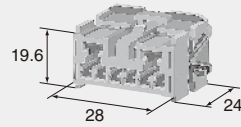

Color Natural

14way (12+2)

Color Natural

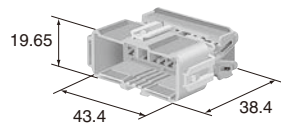

M (6098-4660)

F (6098-3565)

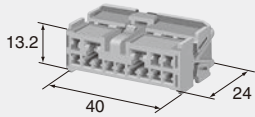

Color Natural

16way (14+2)

F (6950-1054)

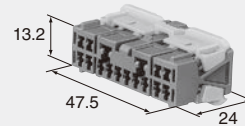

Color Green

20way (16+4)

F (6950-1056)

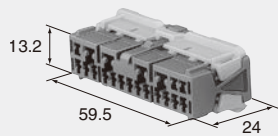

Color Green

8.0mm (312)

(E)	(J)
Cable size	: 適用電線サイズ
Cable overall diameter	: 電線仕上り外径
Heat-resistant copper alloy	: 耐熱銅合金
Brass	: 黄銅
Surface treatment	: 表面処理
Gold-plated	: Auメッキ
Tin-plated	: Snメッキ

Terminal (UNIT : mm)

(M)

Cable size (mm²) 2.0~3.0

Cable overall diameter (mm) 2.6~4.1

Material Brass

Surface treatment Tin-plated

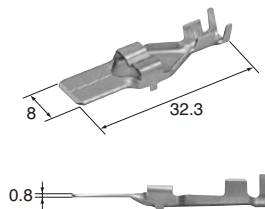

M (8100-0521)

F (8100-0706)

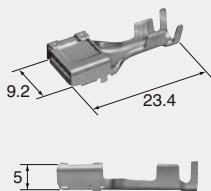

Cable size (mm²) 2.0~3.0

Cable overall diameter (mm) 2.6~4.1

Material Brass

Surface treatment Tin-plated

(S)

Cable size (mm²) 0.5~1.25

Cable overall diameter (mm) 1.6~2.9

Material Brass

Surface treatment Tin-plated

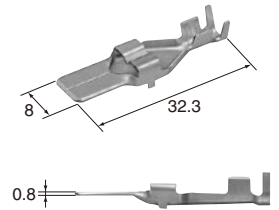

M (8100-0520)

F (8100-0707)

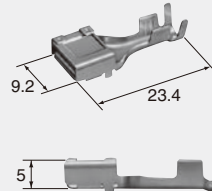

Cable size (mm²) 0.5~1.25

Cable overall diameter (mm) 1.6~2.9

Material Brass

Surface treatment Tin-plated

(L)

Cable size (mm²) 5.0~8.0

Cable overall diameter (mm) 4.4~5.8

Material Brass

Surface treatment Tin-plated

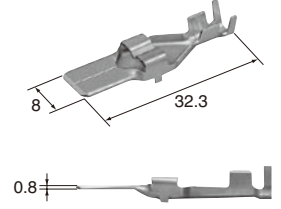

M (8100-0522)

F (8100-1553)

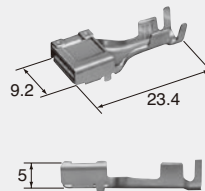

Cable size (mm²) 5.0~8.0

Cable overall diameter (mm) 4.4~5.8

Material Heat-resistant copper alloy

Surface treatment Tin-plated

4.8mm, 8.0mm (187, 312)

Housing (UNIT : mm)

Ref: Terminal part No. [4.8mm] C-12
[8.0mm] C-21

Material PBT

No. of way/ () corresponds to 4.8mm, 8.0mm, in order from left to right.
極数/ () 内表示: 左から4.8mm 極数、8.0mm 極数

6way (4+2)

F (6098-3569)

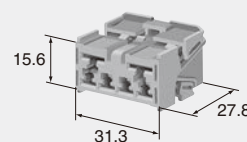

Color Natural

HE SERIES for PCB

1.0mm (O40)

Housing (UNIT : mm)

Material

PBT G30

13way

(Vertical type)

M (6098-3239)

● Detailed dimension
寸法詳細

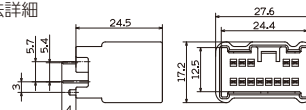

● Recommended dimension of Circuit board
基板推奨詳細

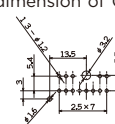

Connector F part No. 6098-2784 (C-08)

Color Natural

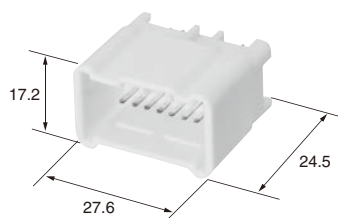
1.0mm, 2.3mm
(O40, O90)

Housing (UNIT : mm)

Material

PBT G30

23way

(Vertical type)

M (6098-3572)

● Detailed dimension
寸法詳細

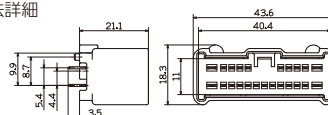

● Recommended dimension of Circuit board
基板推奨詳細

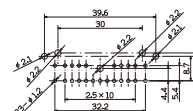

Connector F part No. 6098-3571 (C-18)

Color Natural

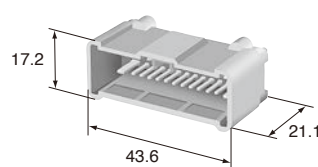

1.0mm, 4.8mm
(040, 187)

Housing (UNIT : mm)

Material PBT G30

14way

M (6098-4018)

Connector F part No. 6098-4017 (C-19)

Color Natural

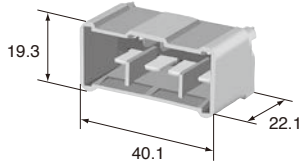

(Vertical type)

●Detailed dimension
寸法詳細

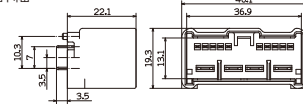

●Recommended dimension of Circuit board
基板推奨詳細

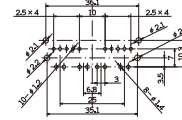

2.3mm (090)

Housing (UNIT : mm)

Material PBT G30

6way

M (6098-3616)

Connector F part No. 6098-1377 (C-11)

Color Sky Blue

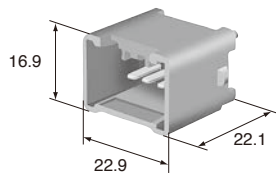

(Vertical type)

●Detailed dimension
寸法詳細

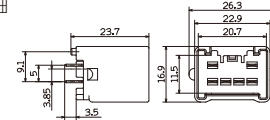

●Recommended dimension of Circuit board
基板推奨詳細

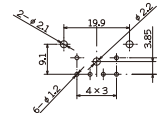

HE SERIES CONNECTOR ACCESSORIES

Mounting Clip (mm)

The clip can be installed to connector M, if necessary, to fasten into the body side hole.
Mコネクタには、ボデー側の穴に固定するためのクランプを必要に応じて取付けることができます。

(6810-1203)

Clip fitting hole size(mm)	φ7
Clip fitting thickness(mm)	t=0.65~1.6
Material	6 Nylon
Color	Red

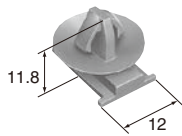

(6810-1217)

Clip fitting hole size(mm)	φ7
Clip fitting thickness(mm)	t=1.6~2.6
Material	6 Nylon
Color	Brown

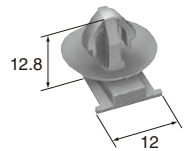

(6810-1204)

Clip fitting hole size(mm)	φ10
Clip fitting thickness(mm)	t=0.65~1.6
Material	6 Nylon
Color	Natural

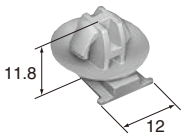

(6810-1462)

Clip fitting hole size(mm)	6×12 (Square hole)
Clip fitting thickness(mm)	t=0.65~1.6
Material	6 Nylon
Color	Orange

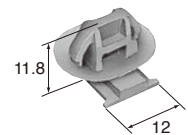

Bracket(support)

Connector M can be accoupled with clamp, if necessary, to fasten to the body side bracket.
Mコネクタには、ボデー側のブラケットに固定するためのクランプを必要に応じて取付けることができます。

(6910-0119)

Bracket direction	Connector mating direction
Material	6 Nylon
Color	Red

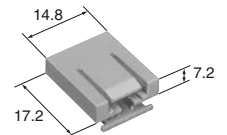

(6910-0120)

Bracket direction	Anti clock wise
Material	6 Nylon
Color	Natural

