

SL SEALED SERIES

The image shows several SL SEALED SERIES connectors on a dark, wet surface. There are four connectors in total: two are grey and two are black. One black connector is in the foreground, connected to four orange wires. The background is a soft-focus view of the other connectors and water droplets on the surface.

Features

The SL sealed connector series is adopted a mechanism that detects terminal incomplete insertion by using a dedicated jig.

These connectors can be directly secured to a stay on the car body. In addition, an extra clip can be attached to the connector to secure it to the car body.

(Note: Please contact our sales staff, if you have any questions regarding the dedicated jig.)

特 長

SL 防水シリーズは、専用治具にて端子半挿入を検出する構造を採用しております。

コネクタは、ボデー側のブラケットに直接固定することができます。

またコネクタにはボデーに固定するためのクランプ（クリップ）を装着することができます。

注意：専用の導通治具に関しては弊社営業担当にご確認下さい。

SL SEALED SERIES for STANDARD

1.5mm (060)

Structure

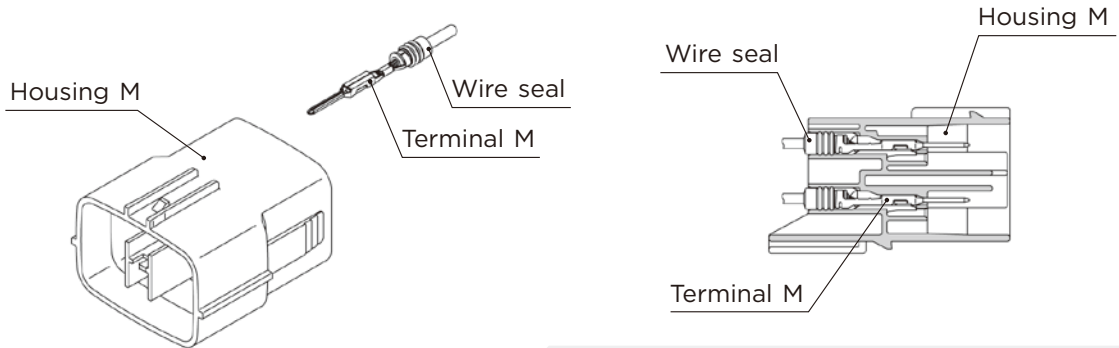

Connector M

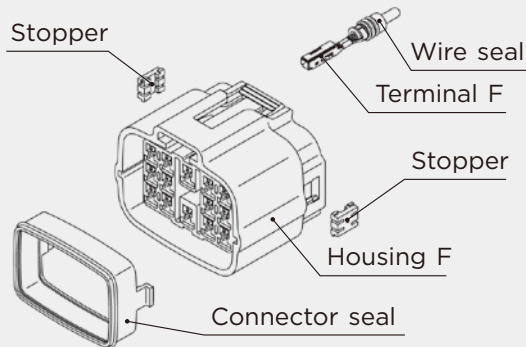

Connector F

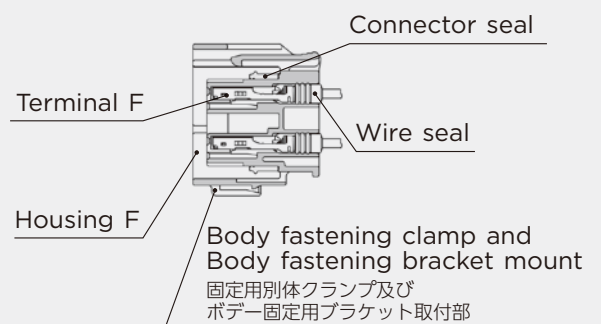

1.5mm (060)

(E)	(J)
Cable size	: 適用電線サイズ
Cable overall diameter	: 電線仕上り外径
Heat-resistant copper alloy	: 耐熱銅合金
Brass	: 黄銅
Surface treatment	: 表面処理
Gold-plated	: Auメッキ
Tin-plated	: Snメッキ

Terminal (UNIT: mm)

※ For terminal selection, please contact our sales staff.

※ターミナル選定にあたっては、必ず弊社営業担当にお問い合わせください。

(S)

Cable size (mm²)	0.3~0.5
Material	Heat-resistant copper alloy
Surface treatment	Tin-plated

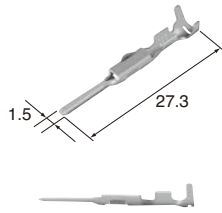
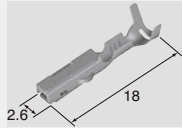
**M (8100-3388)**

Cable size (mm²)	0.3~0.5
Material	Heat-resistant copper alloy
Surface treatment	Tin-plated

F (8100-3397)**(S)****Au**

Cable size (mm²)	0.3~0.5
Material	Heat-resistant copper alloy
Surface treatment	Gold-plated

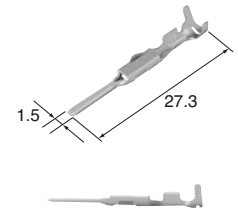
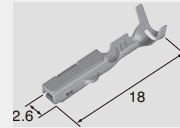
**M (8100-3504)**

Cable size (mm²)	0.3~0.5
Material	Heat-resistant copper alloy
Surface treatment	Gold-plated

F (8100-3402)**(M)**

Cable size (mm²)	0.75~0.85
Material	Heat-resistant copper alloy
Surface treatment	Tin-plated

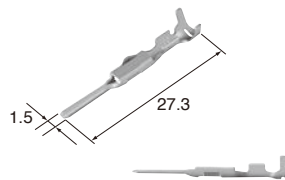
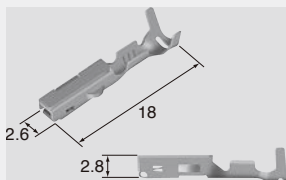
**M (8100-3389)**

2.8

Cable size (mm²)	0.75~0.85
Material	Heat-resistant copper alloy
Surface treatment	Tin-plated

F (8100-3398)**(M)****Au****M (8100-3403)**

Cable size (mm²)	0.75~0.85
Material	Heat-resistant copper alloy
Surface treatment	Gold-plated

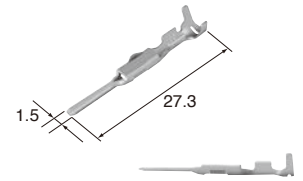
**J-03**

SL SEALED SERIES

(L)

Cable size (mm²)	1.25~2.0
Material	Heat-resistant copper alloy
Surface treatment	Tin-plated

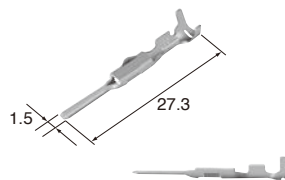
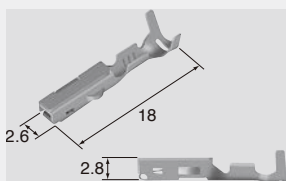
**M (8100-3390)**

2.8

Cable size (mm²)	1.25~2.0
Material	Heat-resistant copper alloy
Surface treatment	Tin-plated

F (8100-3399)

1.5mm (060)

Wire seals (UNIT : mm)

Ref; 1.5mm Terminal detail

S (7165-0516) J-07

M (7165-0515) J-07

L (7165-0514) J-07

1.5mm (060)

Dummy plugs (UNIT : mm)

Ref; 1.5mm Dummy plug detail

(7161-9787) B-17

(7165-0193) J-07

J-04

1.5mm (060)

Housing (UNIT : mm)

Ref: Terminal part No. J-02

Ref: wire seal No. J-06

Ref: Dummy plug No. B-17
J-07

Material PBT

2way

Color Black

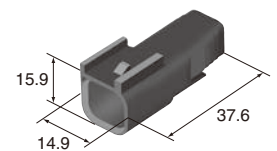

M (6181-6614)

F (6189-1076)

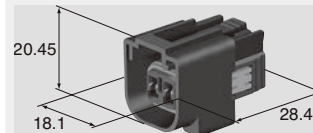

Color Black

2way

Color Dark Gray

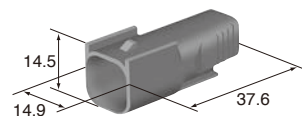

M (6181-6509)

F (6189-1073)

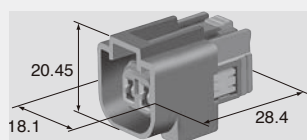

Color Dark Gray

2way

Color Black

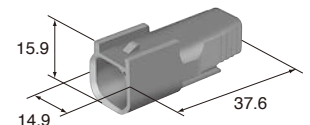

M (6181-6492)

F (6189-1115)

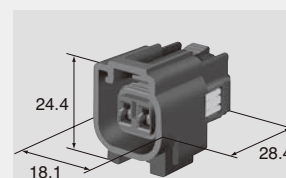

Color Black

Note J-11
Clamp:TYPE1

2way

F (6189-1147)

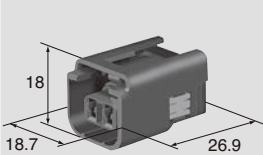

Color Black

2way

F (6189-1144)

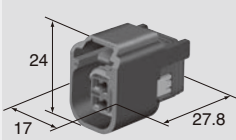

Color Black

2way

F (6189-1150)

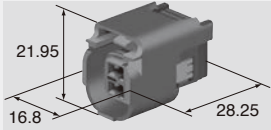

Color Dark Gray

2way

F (6189-1149)

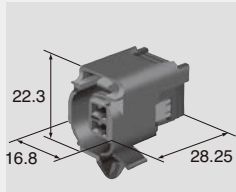

Color Dark Gray

3way

F (6189-7115)

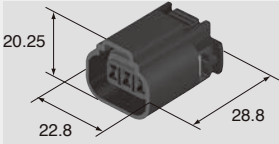

Color Black

14way

Color Dark Gray

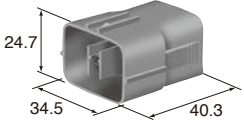

M (6181-0629)

F (6189-7262)

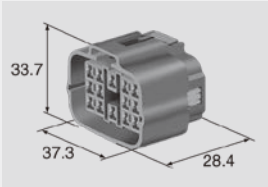

Color Dark Gray

Note J-11
Clamp:TYPE1

J-05
SL SEALED SERIES

SL SEALED SERIES for STANDARD

2.3mm (090)

Structure

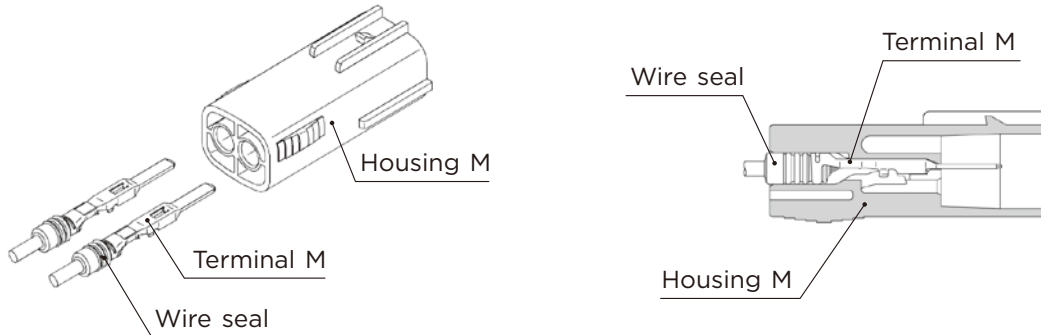

Connector M

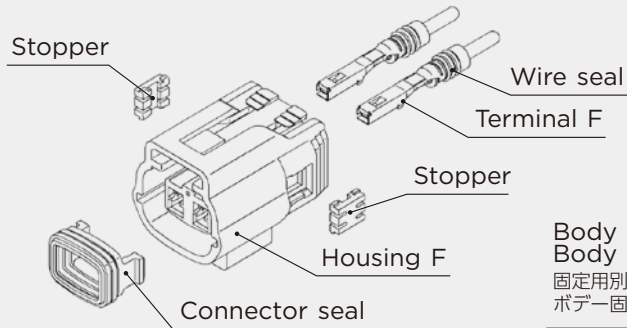

Connector F

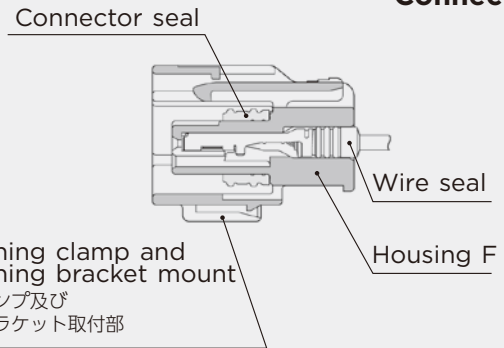

Body fastening clamp and
Body fastening bracket mount
固定用別体クランプ及び
ポデー固定用ブラケット取付部

2.3mm (090)

Terminal (UNIT : mm)

Ref; 2.3mm Terminal detail

S (8230-4472) L-03 **F (8100-1427)** L-03

M (8230-4562) L-03 **F (8100-1429)** L-03

L (8230-4552) L-03 **F (8100-1428)** L-03

Regarding "Gold-plated Terminal", please refer "L-03".
AuメッキターミナルはL-03ご参照

2.3mm (090)

Wire seals (UNIT : mm)

The wire seals are common to M and F.
ワイヤシールはM、F 共用です。

(S)**(7165-0516)**

Cable overall diameter(mm) Over than 1.4 mm below 1.6 mm

Material Silicone

Color Black

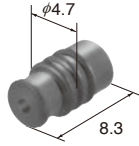
**(M)****(7165-0515)**

Cable overall diameter(mm) Over than 1.6 mm below 2.4 mm

Material Silicone

Color Gray

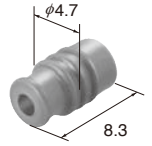
**(L)****(7165-0514)**

Cable overall diameter(mm) Over than 2.4 mm below 2.7 mm

Material Silicone

Color Dark Green

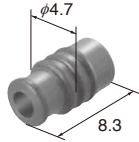

2.3mm (090)

Dummy plugs (UNIT : mm)

Ref; 2.3mm Dummy plug detail

(7161-9787) B-17

- Dummy plugs are common to M and F.
- Dummy plugs are used to blind unused terminal holes.
- ダミー栓はM、F 共用です。
- 不必要なターミナル穴を塞ぐために、ダミー栓を使用します。

2.3mm (090)

Housing (UNIT : mm)

Ref: Terminal part No. L-02

Ref: wire seal No. J-06

Ref: Dummy plug No. B-17
J-07

Material PBT

(P5)**(7165-0193)**

Material Silicone

Color Green

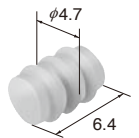

1way

Color Dark Gray

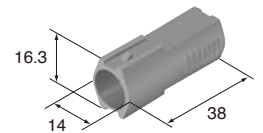
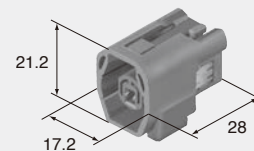
**M (6181-0436)****F (6189-0639)**

Color Dark Gray

Note J-11
Clamp:TYPE1

2way

Color Dark Gray

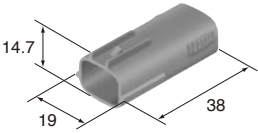

M (6181-0437)

F (6189-8152)

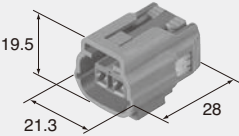

Color Dark Gray
Note J-11
Clamp:TYPE1

3way

Color Dark Gray

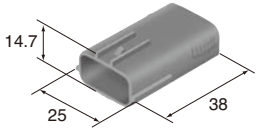

M (6181-0438)

F (6189-7784)

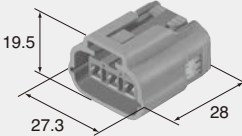

Color Dark Gray
Note J-11
Clamp:TYPE1

4way

Color Dark Gray

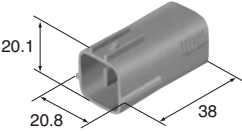

M (6181-0439)

F (6189-0643)

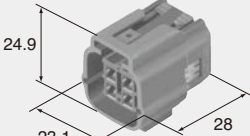

Color Dark Gray
Note J-11
Clamp:TYPE1

6way

Color Dark Gray

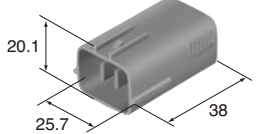

M (6181-0440)

F (6189-0648)

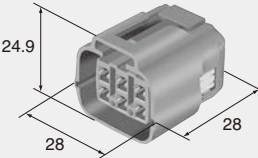

Color Dark Gray
Note J-11
Clamp:TYPE1

SL SEALED SERIES for STANDARD

8.0mm (312)

Structure

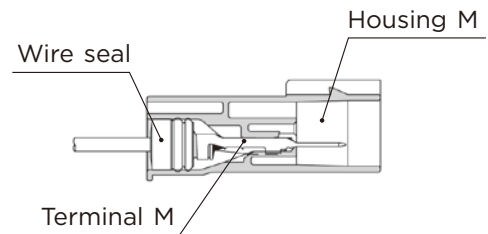
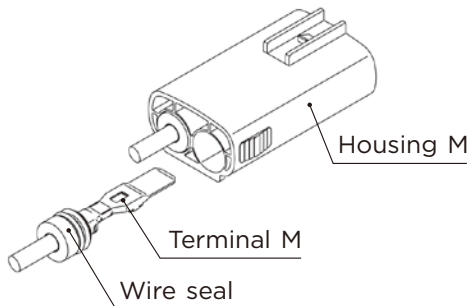

Connector M

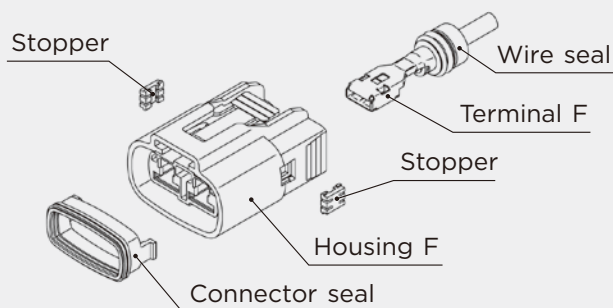

Connector F

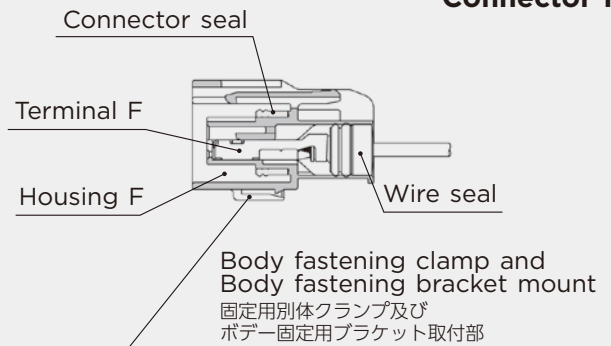

J-09

SL SEALED SERIES

8.0mm (312)

(E)	(J)
Cable size	: 適用電線サイズ
Cable overall diameter	: 電線仕上り外径
Heat-resistant copper alloy	: 耐熱銅合金
Brass	: 黄銅
Surface treatment	: 表面処理
Gold-plated	: Auメッキ
Tin-plated	: Snメッキ

Terminal (UNIT: mm)

※ For terminal selection, please contact our sales staff.

※ターミナル選定にあたっては、必ず弊社営業担当にお問い合わせください。

(M)

Cable size (mm ²)	2.0~3.0
Material	Brass
Surface treatment	Tin-plated

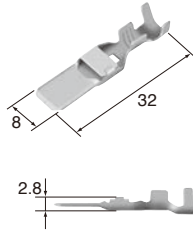
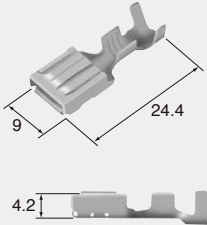
**M (8100-3259)****F (8100-3257)**

Cable size (mm ²)	2.0~3.0
Material	Heat-resistant copper alloy
Surface treatment	Tin-plated

(L)

Cable size (mm ²)	5.0~8.0
Material	Brass
Surface treatment	Tin-plated

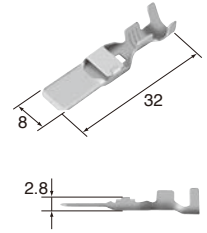
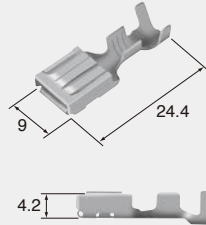
**M (8100-3260)****F (8100-3258)**

Cable size (mm ²)	5.0~8.0
Material	Heat-resistant copper alloy
Surface treatment	Tin-plated

J-10

8.0mm (312)

Wire seals (UNIT : mm)

Ref; 8.0mm Wire Seals detail

SS (7165-0683) B-26**S (7165-0400)** B-26**M (7165-0392)** B-26**L (7165-0393)** B-26

The wire seals are common to M and F.
ワイヤシールはM、F 共用です。

8.0mm (312)

Housing (UNIT : mm)

Ref: Terminal part No. J-09

Ref: wire seal No. B-26

Ref: Dummy plug No. B-27

Material PBT

8.0mm (312)

Dummy plugs (UNIT : mm)

Ref; 8.0mm Dummy plug detail

(7165-0180) B-27

- Dummy plugs are common to M and F.
- Dummy plugs are used to blind unused terminal holes.
- ダミー栓はM、F 共用です。
- 不必要なターミナル穴を塞ぐために、ダミー栓を使用します。

2way

Color Dark Gray

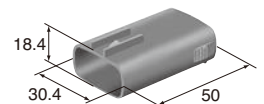
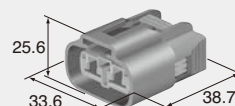
**M (6181-0613)****F (6189-0915)**

Color	Dark Gray
Note	J-11 Clamp:TYPE1

SL SEALED SERIES CONNECTOR ACCESSORIES

Type 1

(6810-1584)

Material	PBT
Color	Brown
hole size	7.2×10.2
Plate thickness range for clamp クランプ適合板厚	t=0.7~2.0

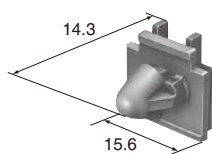

Mounting clip (mm)

Mounting clip can be installed on the standard type connectors.
※ The detail dimensions for the mounting portion are specified on the drawing.

1.5mm 標準・2.3mm 標準・8.0mm 標準のコネクタには、ボデー固定用クランプを必要に応じて取付けることができます。
※取付部詳細寸法は、別途図面により規定します。