

TS SERIES



Features

The TS connector series has a mechanism of Terminal Position Assurance.

TPA/Retainers are pre-mounted on the connector housing.

The connector mechanism only allows the TPA/Retainer to be set when the terminal is completely inserted.

These connectors can be directly secured to a Stay/Support on the car body.

PCB models are also available for connection to printed circuit boards.

特長

本シリーズはターミナルが半挿入の状態では、リテーナが装着できない機構になっています。リテーナはあらかじめコネクタに取り付けられています。

また、コネクタは、ボデー側のブラケットに直接固定することができます。

PCBタイプもご用意しています。

TS SERIES for STANDARD

0.64mm (025)

A-02

Structure / Detecting structure for incomplete terminal insertion.

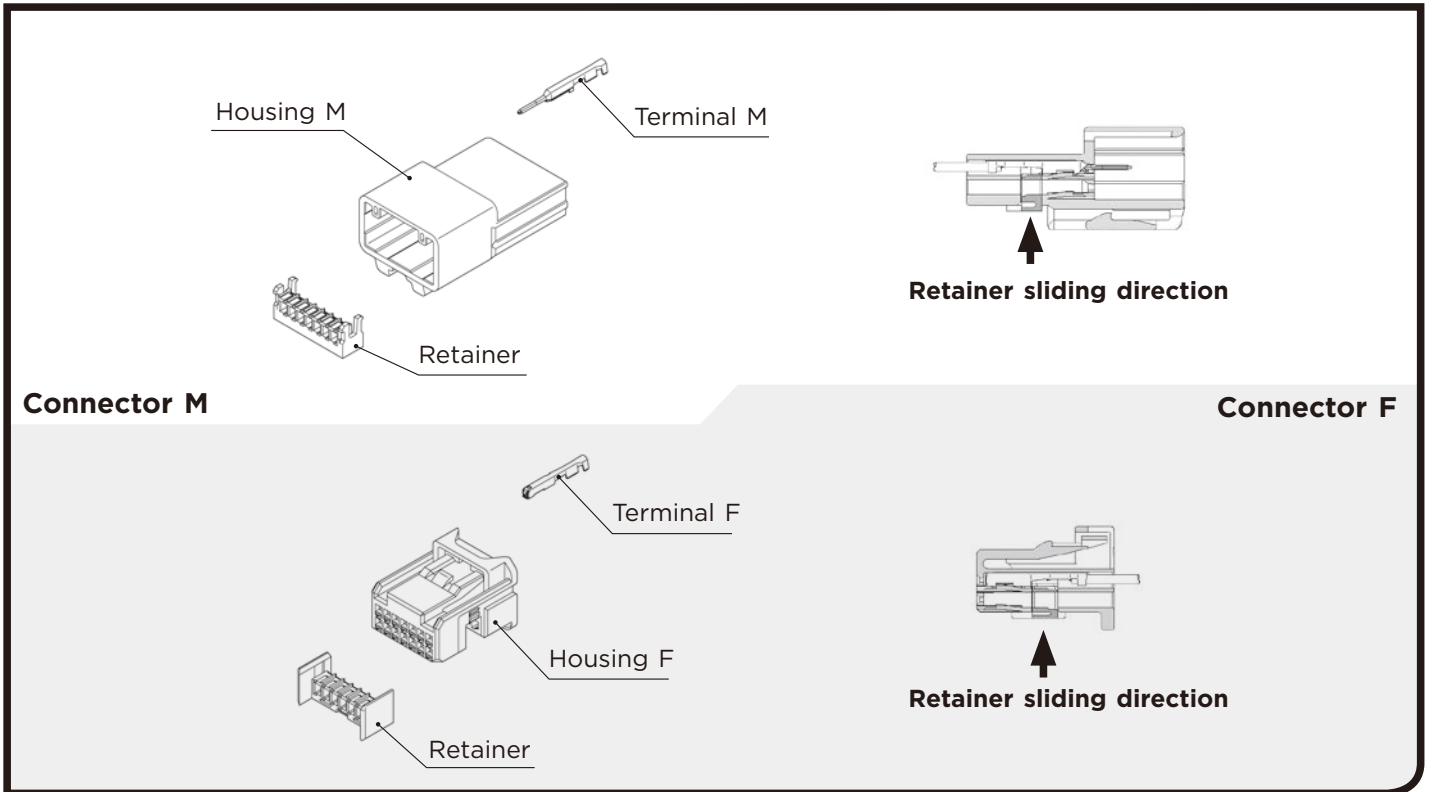

0.64mm (025)

(E)	(J)
Cable size	: 適用電線サイズ
Cable overall diameter	: 電線仕上り外径
Heat-resistant copper alloy	: 耐熱銅合金
Brass	: 黄銅
Surface treatment	: 表面処理
Gold-plated	: Auメッキ
Tin-plated	: Snメッキ

Terminal (UNIT : mm)

(S)

Cable size (mm ²)	0.13
Material	Brass
Surface treatment	Tin-plated

M (8230-4878) **F (8240-0182)**

Cable size (mm ²)	0.13
Material	Heat-resistant copper alloy
Surface treatment	Tin-plated

(S) **Au**

Cable size (mm ²)	0.13
Material	Brass
Surface treatment	Gold-plated

M (8230-5136) **F (8240-0338)**

Cable size (mm ²)	0.13
Material	Heat-resistant copper alloy
Surface treatment	Gold-plated

(M)

Cable size (mm ²)	0.22~0.35
Material	Brass
Surface treatment	Tin-plated

M (8100-3622) **F (8100-3624)**

Cable size (mm ²)	0.22~0.35
Material	Heat-resistant copper alloy
Surface treatment	Tin-plated

(M) **Au**

Cable size (mm ²)	0.22~0.35
Material	Brass
Surface treatment	Gold-plated

M (8100-3626) **F (8100-3628)**

Cable size (mm ²)	0.22~0.35
Material	Heat-resistant copper alloy
Surface treatment	Gold-plated

(L)

Cable size (mm ²)	0.3~0.5
Material	Brass
Surface treatment	Tin-plated

M (8100-3623) **F (8100-3625)**

Cable size (mm ²)	0.3~0.5
Material	Heat-resistant copper alloy
Surface treatment	Tin-plated

(L) **Au**

Cable size (mm ²)	0.3~0.5
Material	Brass
Surface treatment	Gold-plated

M (8100-3627) **F (8100-3629)**

Cable size (mm ²)	0.3~0.5
Material	Heat-resistant copper alloy
Surface treatment	Gold-plated

0.64mm (O25)

A-04

Housing (UNIT : mm)

Ref: Terminal part No. A-02

Material PBT

2way

Color Natural

Note:Bracket size 9mm

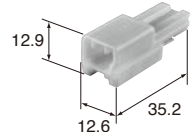

M (6098-6653)

F (6098-6662)

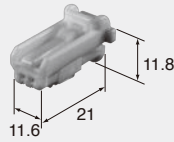

Color Natural

5way

Color Natural

Note:Bracket size 9mm

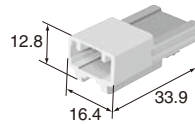

M (6098-3802)

F (6098-3810)

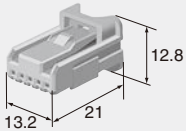

Color Natural

10way

Color Natural

Note:Bracket size 9mm

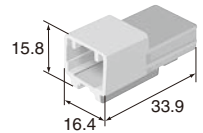

M (6098-3869)

F (6098-3909)

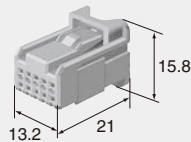

Color Natural

14way

Color Natural

Note:Bracket size 9mm

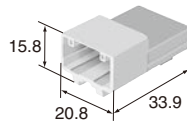

M (6098-3877)

F (6098-3917)

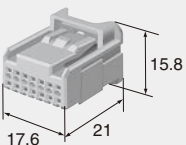

Color Natural

14way

F (6098-7241)

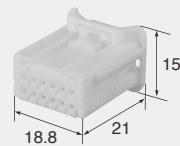

PCB Connector part No. 6098-7229 (A-26)

Color Natural

16way

Color Natural

Note:Bracket size 17mm

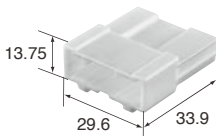

M (6098-7336) **F (6098-4008)**

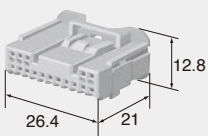

PCB Connector part No. 6098-6790 (A-26)
6098-6793 (A-26)

Color Natural

16way

F (6098-6688)

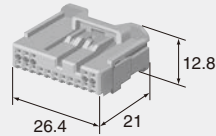

PCB Connector part No. 6098-6848 (A-27)

Color Natural

16way

F (6098-6694)

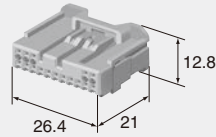

PCB Connector part No. 6098-6848 (A-27)

Color Natural

19way

F (6098-7231)

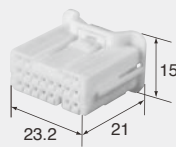

PCB Connector part No. 6098-7229 (A-26)

Color Natural

22way

Color Natural

Note:Bracket size 17mm

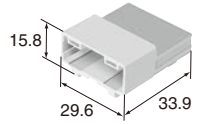

M (6098-3885) **F (6098-3925)**

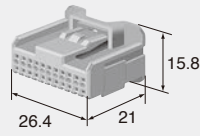

Color Natural

24way

F (6098-4010)

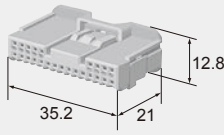

PCB Connector part No. 6098-6803 (A-27)

Color Natural

24way

F (6098-6682)

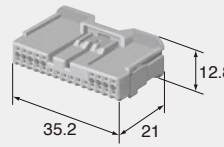

PCB Connector part No. 6098-6848 (A-27)

Color Natural

28way

F (6098-4756)

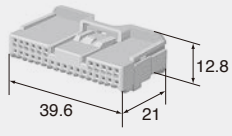

PCB Connector part No. 6098-6805 (A-27)
6098-7102 (A-28)
6098-6810 (A-28)

Color Natural

32way

F (6098-4013)

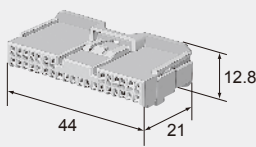

Color Natural

36way

F (6098-4740)

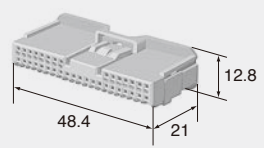

PCB Connector part No. 6098-6796 (A-27)
6098-6798 (A-27)
6098-6803 (A-27)

Color Natural

40way

F (6098-4015)

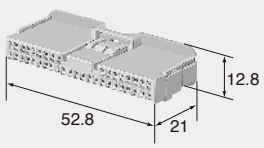

PCB Connector part No. 6098-6810 (A-28)

Color Natural

40way

F (6098-4831)

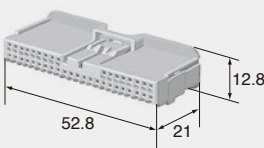

PCB Connector part No. 6098-6805 (A-27)
6098-7102 (A-28)

Color Natural

TS SERIES for STANDARD

1.5mm (060)

A-07

TS SERIES

Structure / Detecting structure for incomplete terminal insertion.

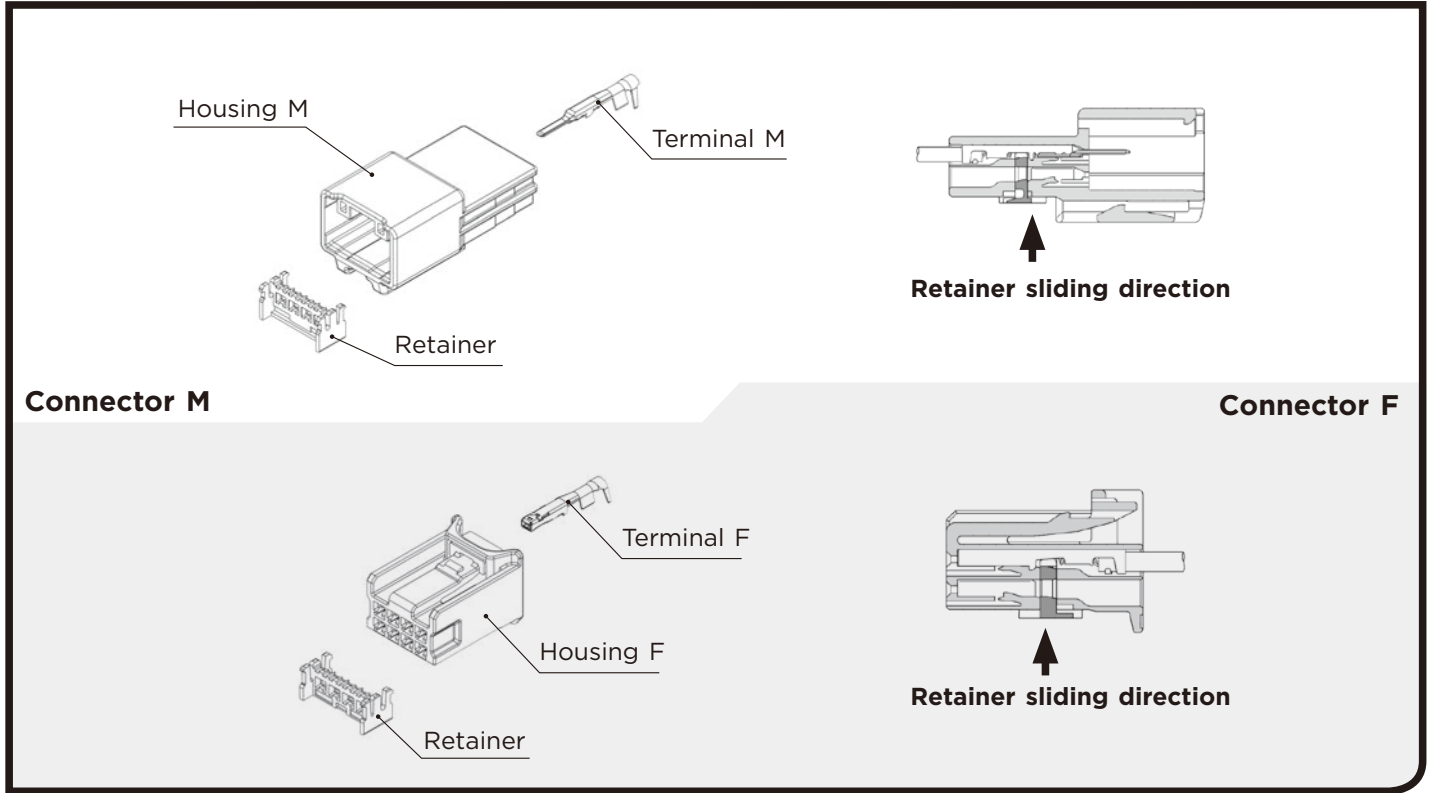

1.5mm (060)

A-08

(E)	(J)
Cable size	: 適用電線サイズ
Cable overall diameter	: 電線仕上り外径
Heat-resistant copper alloy	: 耐熱銅合金
Brass	: 黄銅
Surface treatment	: 表面処理
Gold-plated	: Auメッキ
Tin-plated	: Snメッキ

Terminal (UNIT : mm)

(3S)

F (8240-0339)



Cable size (mm²)	0.13
Material	Heat-resistant copper alloy
Surface treatment	Tin-plated

(S)

Cable size (mm²) 0.3~0.5

Material Brass

Surface treatment Tin-plated

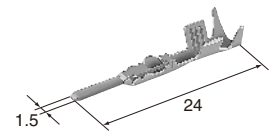

(SS)

F (8240-0279)

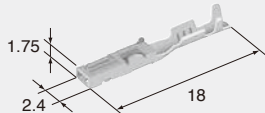

Cable size (mm²)	0.22~0.35
Material	Heat-resistant copper alloy
Surface treatment	Tin-plated

M (8230-4925)

F (8240-0215)

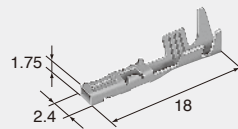

Cable size (mm²)	0.3~0.5
Material	Heat-resistant copper alloy
Surface treatment	Tin-plated

(M)

Cable size (mm²) 0.75~1.25

Material Brass

Surface treatment Tin-plated

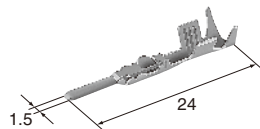

(L)

Cable size (mm²) 2.0

Material Heat-resistant copper alloy

Surface treatment Tin-plated

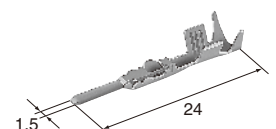

M (8230-4924)

F (8240-0213)

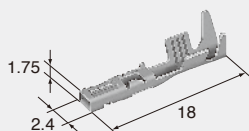

Cable size (mm²)	0.75~1.25
Material	Heat-resistant copper alloy
Surface treatment	Tin-plated

M (8230-4923)

F (8240-0214)

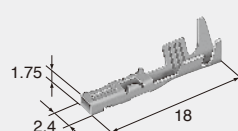

Cable size (mm²)	2.0
Material	Heat-resistant copper alloy
Surface treatment	Tin-plated

1.5mm (060)

Housing (UNIT : mm)

Ref: Terminal part No. A-08

Material PBT

2way

Color Natural

Note:Bracket size 9mm

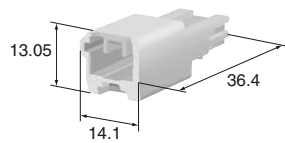

M (6098-6050)

F (6098-6053)

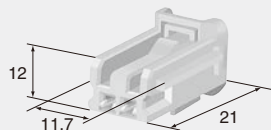

Color Natural

4way

Color Natural

Note:Bracket size 9mm

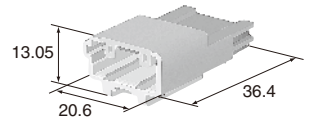

M (6098-5668)

F (6098-5677)

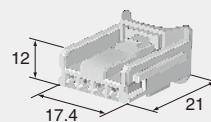

Color Natural

8way

Color Natural

Note:Bracket size 9mm

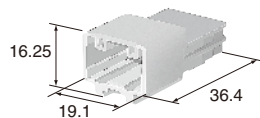

M (6098-5686)

F (6098-5695)

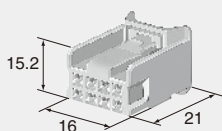

Color Natural

12way

Color Natural

Note:Bracket size 17mm

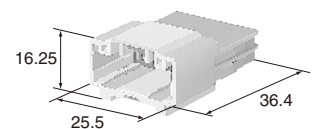

M (6098-5704)

F (6098-5713)

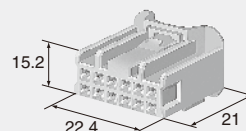

Color Natural

TS SERIES for STANDARD

2.3mm (090)

A-10

Structure / Detecting structure for incomplete terminal insertion.

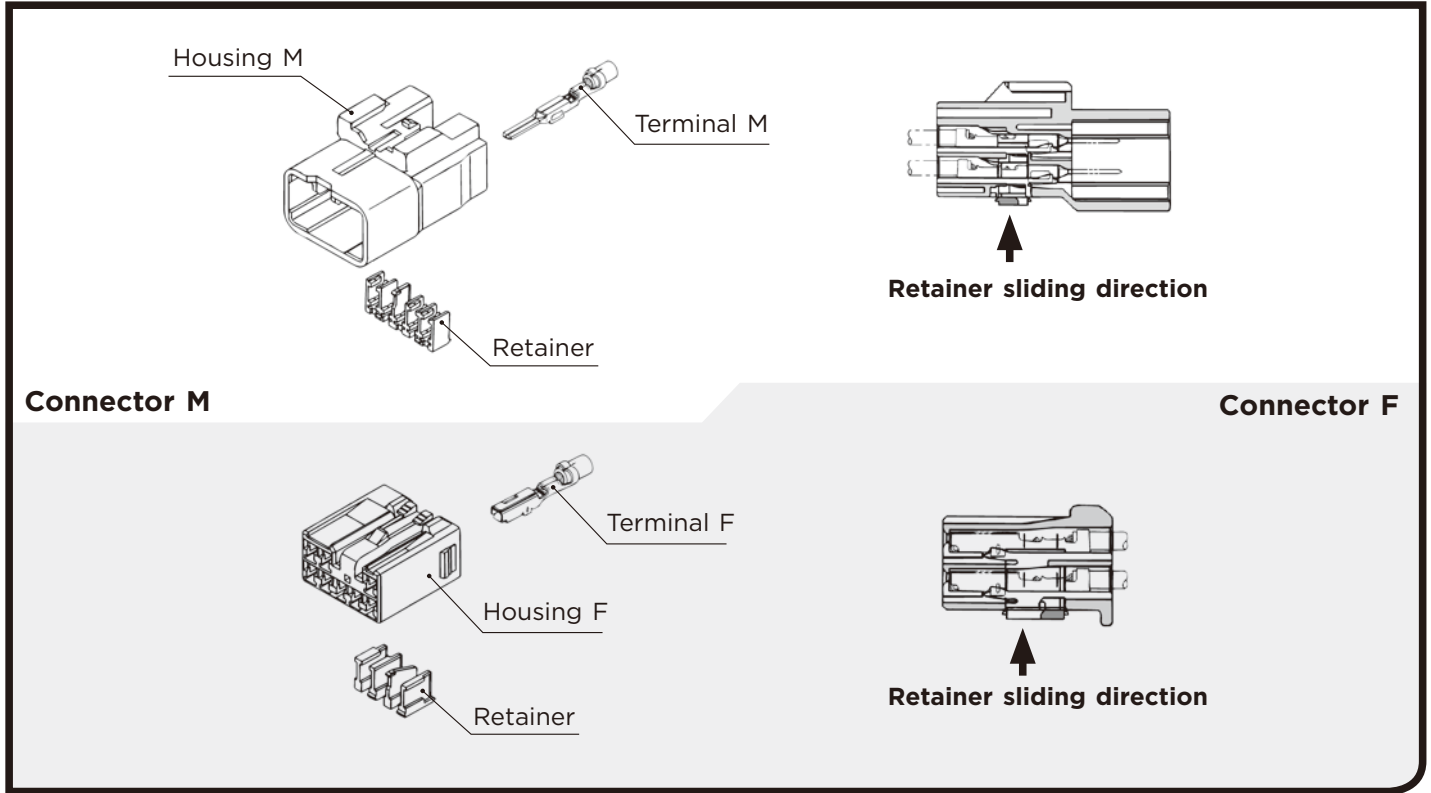

2.3mm (090)

(E)	(J)
Cable size	: 適用電線サイズ
Cable overall diameter	: 電線仕上り外径
Heat-resistant copper alloy	: 耐熱銅合金
Brass	: 黄銅
Surface treatment	: 表面処理
Gold-plated	: Auメッキ
Tin-plated	: Snメッキ

Terminal (UNIT : mm)

(SS)

Cable size (mm²)	0.22~0.35
Material	Brass
Surface treatment	Tin-plated

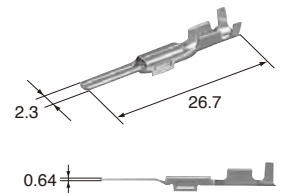

M (8230-4742)

F (8240-0029)

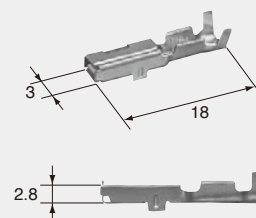

Cable size (mm²)	0.22~0.35
Material	Brass
Surface treatment	Tin-plated

(S)

Cable size (mm ²)	0.3~0.5
Material	Brass
Surface treatment	Tin-plated

M (8230-4492) **F (8240-4882)**

Cable size (mm ²)	0.3~0.5
Material	Brass
Surface treatment	Tin-plated

(S) **Au**

Cable size (mm ²)	0.3~0.5
Material	Brass
Surface treatment	Gold-plated

M (8100-1341) **F (8100-1346)**

Cable size (mm ²)	0.3~0.5
Material	Brass
Surface treatment	Gold-plated

(M)

Cable size (mm ²)	0.5~1.25
Material	Brass
Surface treatment	Tin-plated

M (8230-4502) **F (8240-4892)**

Cable size (mm ²)	0.5~1.25
Material	Brass
Surface treatment	Tin-plated

(M) **Au**

Cable size (mm ²)	0.5~1.25
Material	Brass
Surface treatment	Gold-plated

M (8100-1342) **F (8100-1347)**

Cable size (mm ²)	0.5~1.25
Material	Brass
Surface treatment	Gold-plated

(L)

Cable size (mm ²)	2.0
Material	Brass
Surface treatment	Tin-plated

M (8230-4512) **F (8240-4942)**

Cable size (mm ²)	2.0
Material	Heat-resistant copper alloy
Surface treatment	Tin-plated

2.3mm (090)

A-12

Housing (UNIT : mm)

Ref: Terminal part No.	A-10
Material	PBT/PA6T

1way

Material	PBT
Color	Natural
Note:with clip for oval hole	

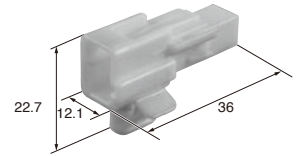

M (6240-1155)

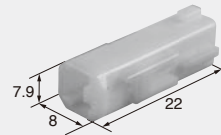

Material	PBT
Color	Natural

F (6240-5214)

1way

Material	PBT
Color	Natural
Note:with clip for oval hole	

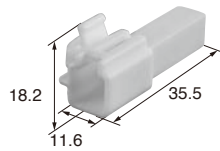

M (6520-0616)

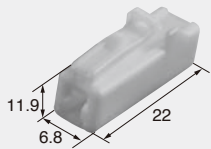

Material	PBT
Color	Natural

F (6520-0564)

2way

Material	PA6T
Color	Natural
Note:Bracket size 9mm	

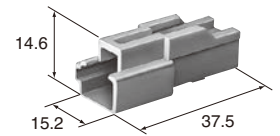

M (6520-0549)

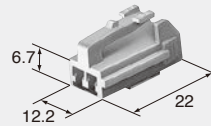

Material	PA6T
Color	Natural

F (6520-0550)

4way

M (1300-4455)

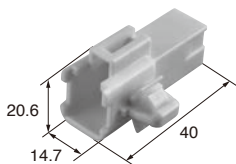

Material	PA6T
Color	Natural
Note:with clip for oval hole	

6way

Material PBT

Color Natural

Note:with clip for round hole

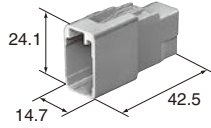

M (6240-1107)

Material PBT

Color Natural

Note:with clip for oval hole

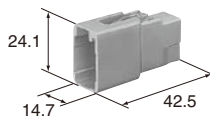

M (6249-1243)

Material PBT

Color Natural

Note:Bracket size 9mm

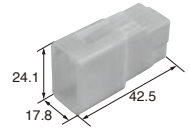

M (6249-1225)

F (6240-5118)

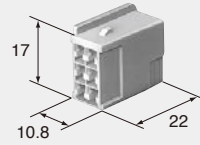

Material PBT
Color Natural

6way

M (6240-1120)

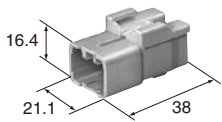

Material PBT
Color Natural

Note:Bracket size 17mm

9way

Material PBT

Color Natural

Note:Bracket size 17mm

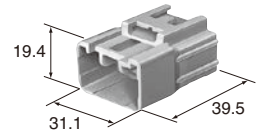

M (6249-1229)

F (6248-5270)

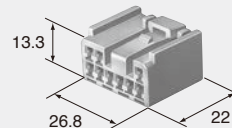

Material PBT
Color Natural

8way

M (6240-1077)

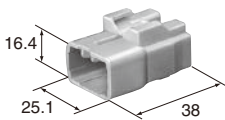

Material PBT
Color Natural

Note:Bracket size 17mm

10way

Material PBT

Color Natural

Note:Bracket size 17mm

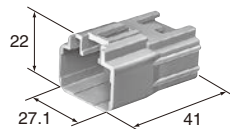

M (6249-1235)

F (6248-5276)

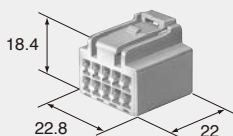

Material PBT
Color Natural

10way

F (1300-3540)

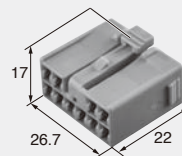

Material PBT
Color Natural

11way

Material	PBT
Color	Natural

Note: Bracket size 17mm

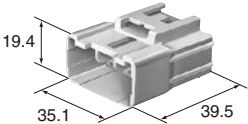

M (6249-1234) **F (6248-5275)**

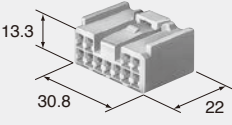

Material	PBT
Color	Natural

12way

Material	PBT
Color	Natural

Note: Bracket size 17mm

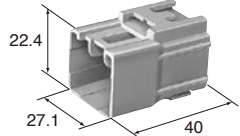

M (6520-1009) **F (6520-1004)**

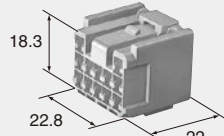

Material	PBT
Color	Natural

12way

F (6520-0355)

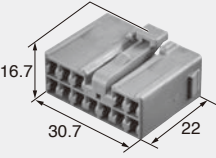

Material	PBT
Color	Natural

13way

Material	PBT
Color	Natural

Note: Bracket size 17mm

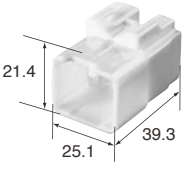

M (6240-1122) **F (6240-5175)**

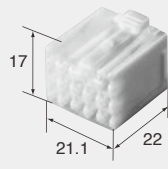

Material	PBT
Color	Natural

13way

F (1300-4682)

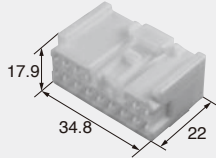

Material	PBT
Color	Natural

16way

Material	PBT
Color	Natural

Note: Bracket size 17mm

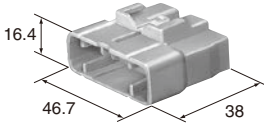

M (6240-1158) **F (6240-5088)**

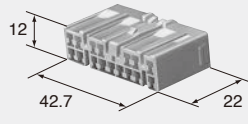

Material	PBT
Color	Natural

20way

Material PBT
Color Natural
 Note:Bracket size 23mm

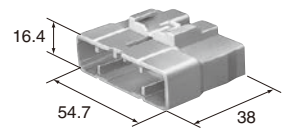

M (6240-1033) **F (6240-5035)**

Material PBT
Color Natural

16way

Material PBT
Color Natural
 Note:Bracket size 17mm

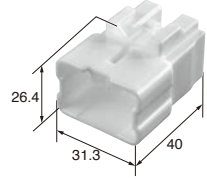

M (6240-1031) **F (6240-5033)**

Material PBT
Color Natural

20way

Material PBT
Color Natural
 Note:Bracket size 17mm

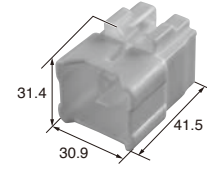

M (6240-1035) **F (6240-5134)**

Material PBT
Color Natural

TS SERIES for STANDARD

4.8mm (187)

A-16

Structure / Detecting structure for incomplete terminal insertion.

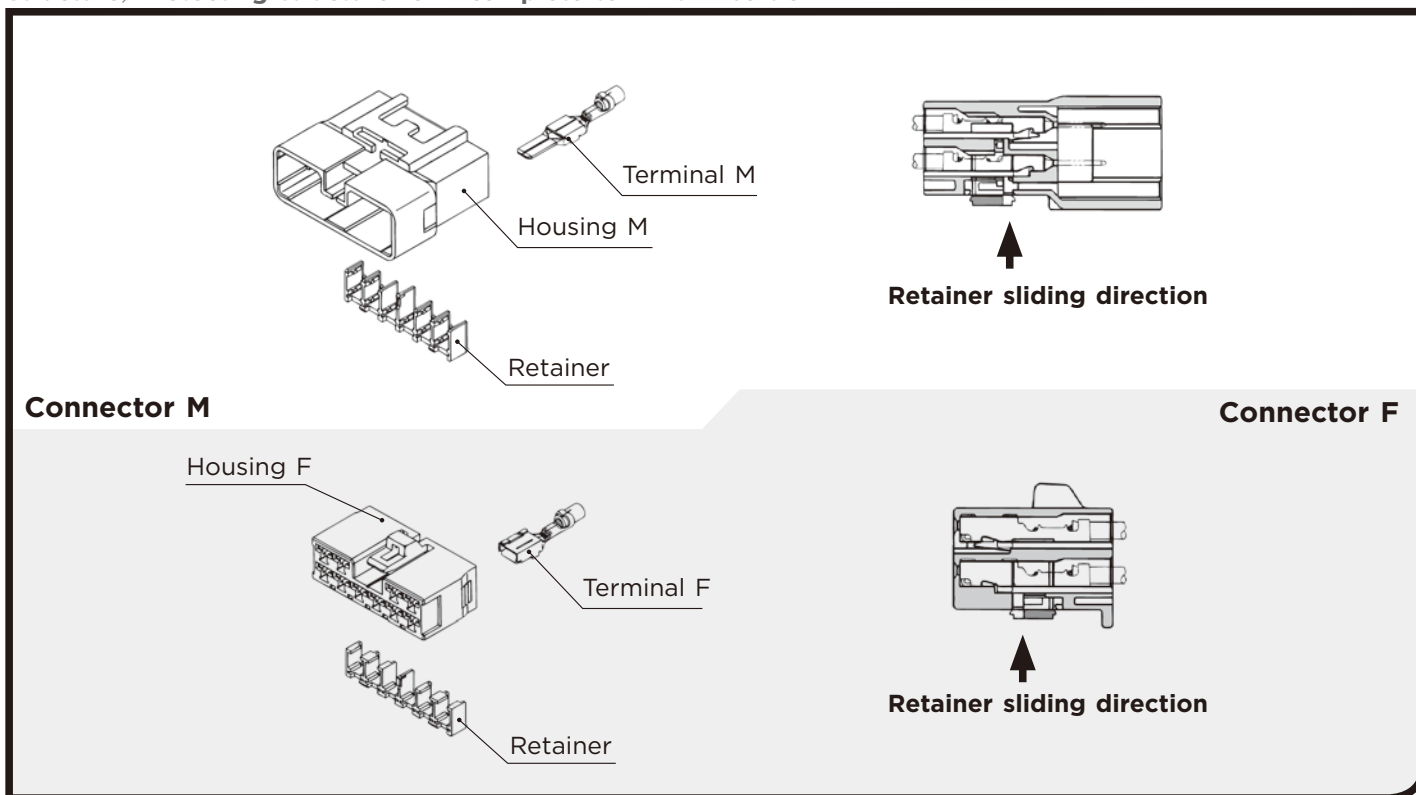

4.8mm (187)

(E)	(J)
Cable size	: 適用電線サイズ
Cable overall diameter	: 電線仕上り外径
Heat-resistant copper alloy	: 耐熱銅合金
Brass	: 黄銅
Surface treatment	: 表面処理
Gold-plated	: Auメッキ
Tin-plated	: Snメッキ

Terminal (UNIT : mm)

(S)

Cable size (mm ²)	0.3~0.5
Material	Brass
Surface treatment	Tin-plated

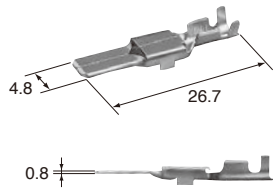

M (8230-4522)

F (8240-4912)

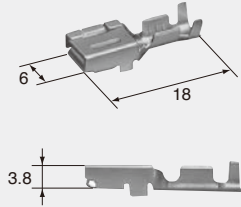

Cable size (mm ²)	0.3~0.5
Material	Brass
Surface treatment	Tin-plated

(M)

Cable size (mm ²)	0.5~1.25
Material	Brass
Surface treatment	Tin-plated

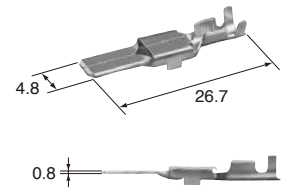

M (8230-4532)

F (8240-4922)

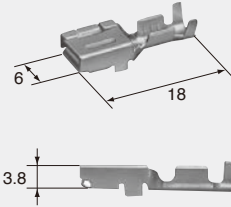

Cable size (mm ²)	0.5~1.25
Material	Brass
Surface treatment	Tin-plated

(L)

Cable size (mm ²)	2.0~3.0
Material	Brass
Surface treatment	Tin-plated

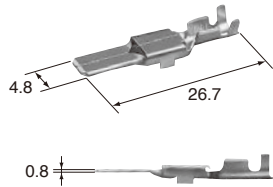

M (8230-4542)

F (8240-4932)

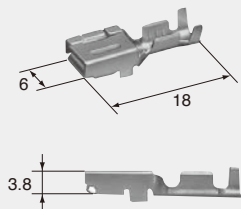

Cable size (mm ²)	2.0~3.0
Material	Brass
Surface treatment	Tin-plated

(L)

F (8100-1555)

Cable size (mm ²)	2.0~3.0
Material	Heat-resistant copper alloy
Surface treatment	Tin-plated

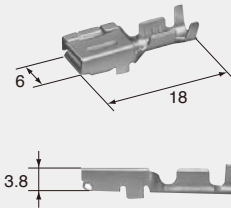

4.8mm (187)

Housing (UNIT : mm)

Ref: Terminal part No.	A-16
Material	PBT

1way

Color	Natural
Note: Bracket size 9mm	

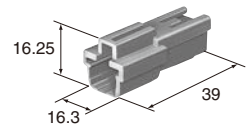

M (6098-0822)

F (6098-0824)

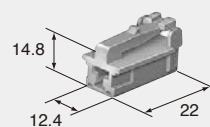

Color	Natural
-------	---------

2way

Color Natural

Note:Bracket size 9mm

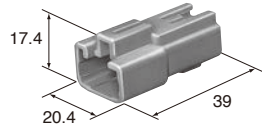

M (6098-0323)

F (6098-0325)

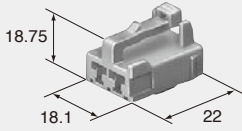

Color Natural

2way

Color Natural

Note:Bracket size 9mm

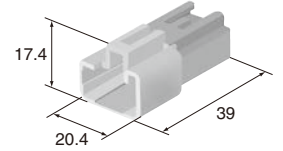

M (6098-0469)

F (6098-0471)

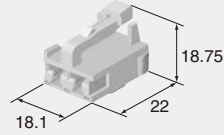

Color Natural

3way

Color Natural

Note:Bracket size 9mm

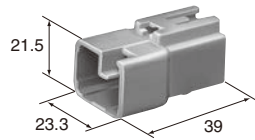

M (6098-0149)

F (6098-0151)

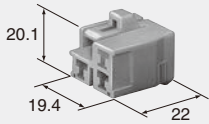

Color Natural

4way

Color Natural

Note:Bracket size 9mm

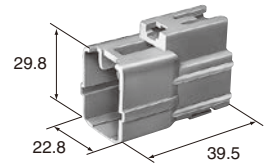

M (6098-1851)

F (6098-1489)

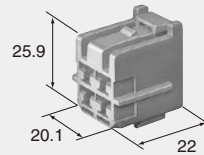

Color Natural

6way

Color Natural

Note:Bracket size 17mm

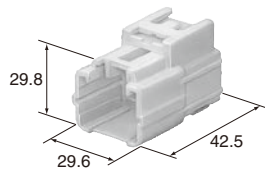

M (6098-2211)

F (6098-1716)

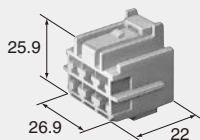

Color Natural

8way

F (6098-0518)

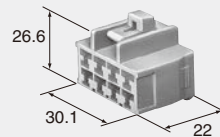

Color Natural

10way

Color Natural

Note: Bracket size 23mm

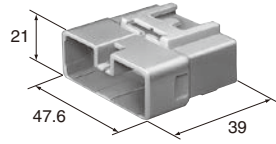

M (6098-0154)

F (6098-0156)

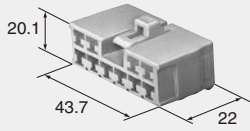

Color Natural

TS SERIES for STANDARD

8.0mm (312)

A-20

Structure / Detecting structure for incomplete terminal insertion.

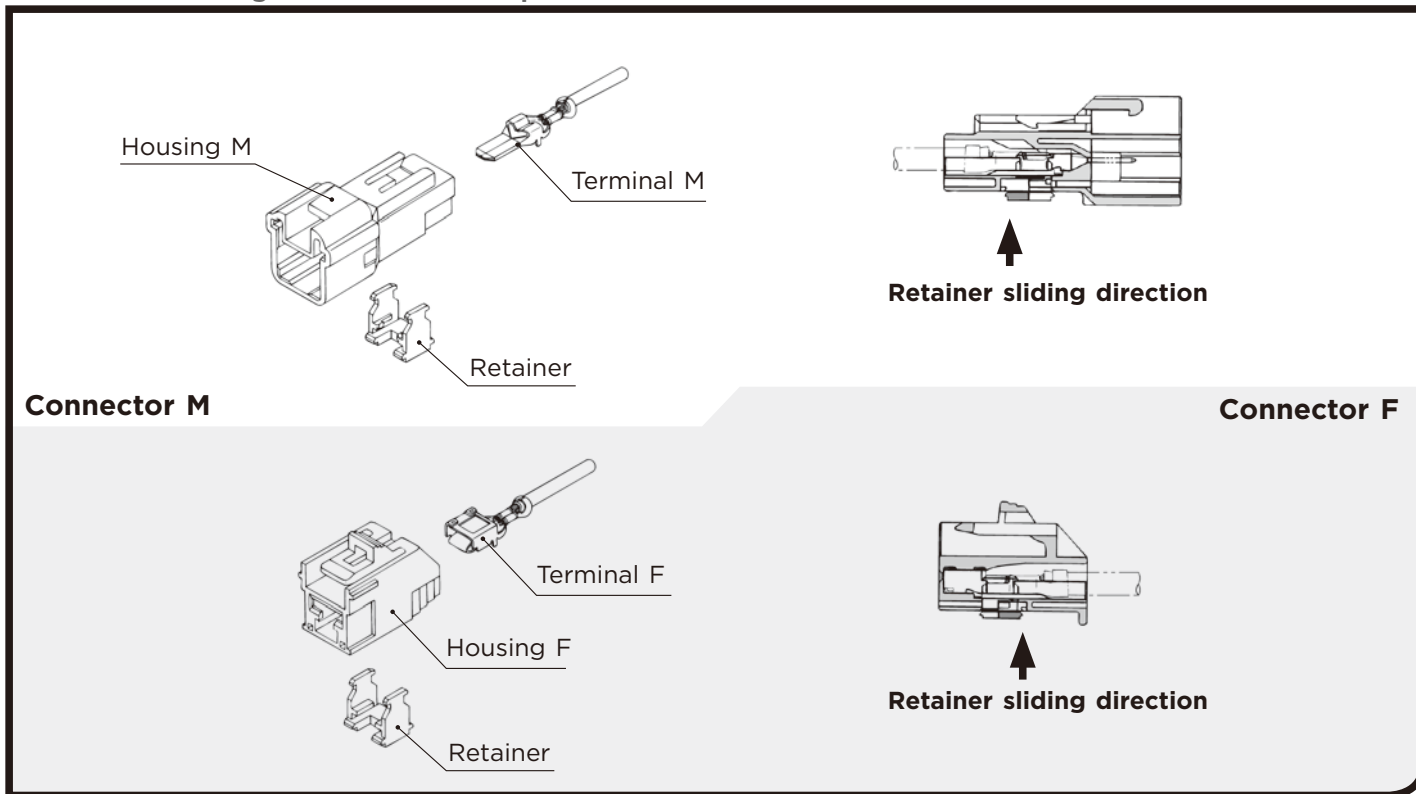

8.0mm (312)

(E)	(J)
Cable size	: 適用電線サイズ
Cable overall diameter	: 電線仕上り外径
Heat-resistant copper alloy	: 耐熱銅合金
Brass	: 黄銅
Surface treatment	: 表面処理
Gold-plated	: Auメッキ
Tin-plated	: Snメッキ

Terminal (UNIT : mm)

(S)

Cable size (mm ²)	0.5~1.25
Material	Brass
Surface treatment	Tin-plated

M (8100-0520)

F (8100-0707)

Cable size (mm ²)	0.5~1.25
Material	Brass
Surface treatment	Tin-plated

(M)Cable size (mm²) 2.0~3.0

Material Brass

Surface treatment Tin-plated

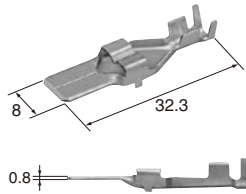
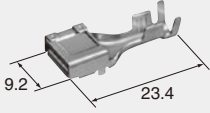
**M (8100-0521)****F (8100-2493)**Cable size (mm²) 2.0~3.0

Material Heat-resistant copper alloy

Surface treatment Tin-plated

(L)Cable size (mm²) 5.0~8.0

Material Brass

Surface treatment Tin-plated

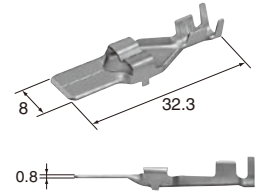
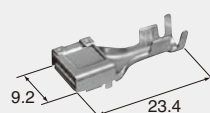
**M (8100-0522)****F (8100-1553)**Cable size (mm²) 5.0~8.0

Material Heat-resistant copper alloy

Surface treatment Tin-plated

8.0mm (312)**Housing** (UNIT : mm)

Ref: Terminal part No. A-20

Material PBT

1way

Color Natural

Note: Bracket size 9mm

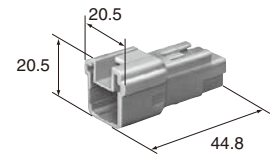
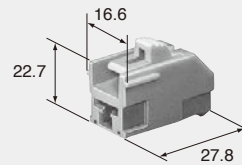
**M (6240-1093)****F (6098-0441)**

Color Natural

2way

Color Natural

Note: Bracket size 17mm

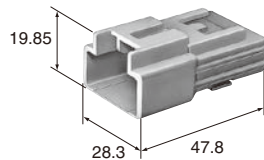
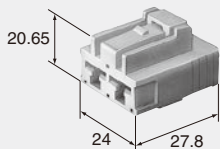
**M (6098-1278)****F (6098-1104)**

Color Natural

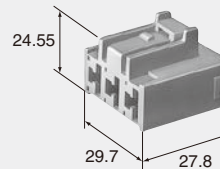
3way**F (6520-1466)**

Color Natural

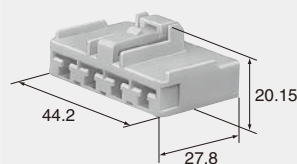
4way**F (6098-2137)**

Color Natural

TS SERIES for HYBRID

0.64mm, 1.5mm (025, 060)

Housing (UNIT : mm)

Ref: Terminal part No. [0.64mm] A-02
[1.5mm] A-08

Material PBT

No. of way/ () corresponds to 0.64mm, 1.5mm, in order from left to right.
極数 / () 内表示 : 左から0.64mm 極数、1.5mm 極数

12way (4+8)

Color Natural

Note: Bracket size 17mm

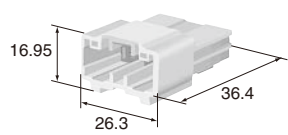

M (6098-6055)

F (6098-6083)

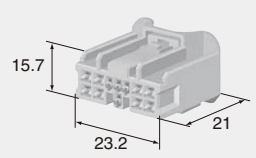

Color Natural

12way (6+6)

Color Natural

Note: Bracket size 17mm

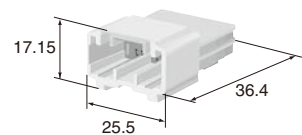

M (6098-6104)

F (6098-6111)

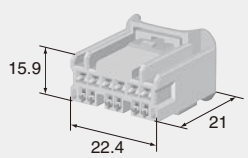

Color Natural

12way (8+4)

Color Natural

Note: Bracket size 17mm

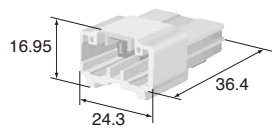

M (6098-6090)

F (6098-6097)

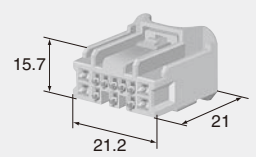

Color Natural

18way (8+10)

Color Natural

Note: Bracket size 17mm

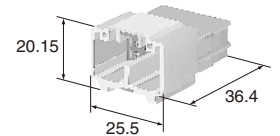

M (6098-5650)

F (6098-5659)

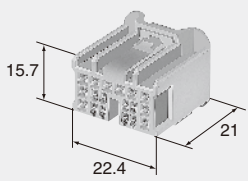

Color Natural

18way (10+8)

Color Natural

Note: Bracket size 17mm

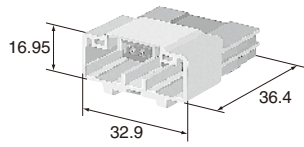

M (6098-5594)

F (6098-5604)

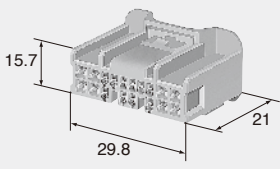

Color Natural

18way (12+6)

Color Natural

Note: Bracket size 17mm

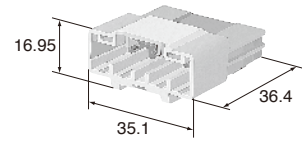

M (6098-5631)

F (6098-5641)

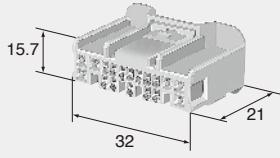

Color Natural

20way (14+6)

F (6098-6876)

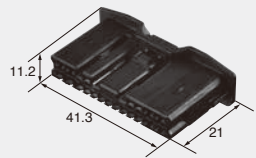

PCB Connector part No. 6098-6869(A-28)

Color Black

20way (16+4)

Color Natural

Note: Bracket size 17mm

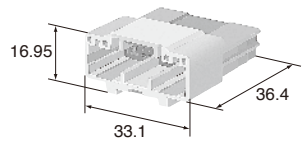

M (6098-5613)

F (6098-5622)

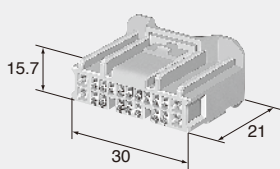

Color Natural

0.64mm, 2.3mm (025, 090)

Housing (UNIT : mm)

Ref: Terminal part No. [0.64mm] A-02
[2.3mm] A-10

Material PBT

No. of way/ () corresponds to 0.64mm, 2.3mm, in order from left to right.
極数 / () 内表示 : 左から0.64mm 極数、2.3mm 極数

17way (8+9)

Color Natural

Note: Bracket size 17mm

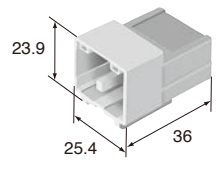

M (6098-3893)

F (6098-3933)

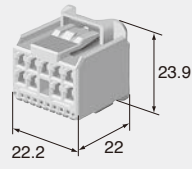

Color Natural

18way (10+8)

Color Natural

Note: Bracket size 17mm

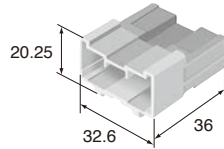

M (6098-3901)

F (6098-3941)

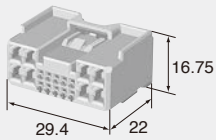

Color Natural

20way (16+4)

Color Natural

Note: Bracket size 17mm

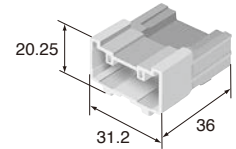

M (6098-3818)

F (6098-3826)

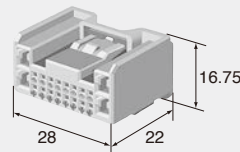

Color Natural

0.64mm, 4.8mm (025, 187)

Housing (UNIT : mm)

Ref: Terminal part No. [0.64mm] A-02
[4.8mm] A-16

Material PBT

No. of way/ () corresponds to 0.64mm, 4.8mm, in order from left to right.
極数 / () 内表示 : 左から0.64mm 極数、4.8mm 極数

20way (18+2)

F (6098-5903)

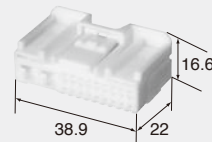

Color Natural

2.3mm, 4.8mm (090, 187)

Housing (UNIT : mm)

Ref: Terminal part No. [2.3mm] A-10
[4.8mm] A-16

Material PBT

No. of way/ () corresponds to 2.3mm, 4.8mm, in order from left to right.
極数 / () 内表示 : 左から2.3mm 極数、4.8mm 極数

14way (12+2)

Color Natural

Note: Bracket size 17mm

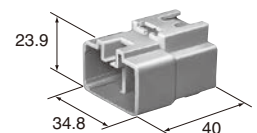

M (6241-0261)

F (6245-0281)

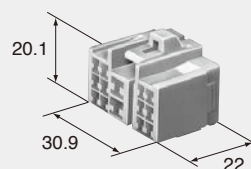

Color Natural

20way (18+2)

Color Natural

Note:Bracket size 17mm

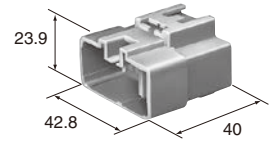

M (6241-0281)

F (6245-0301)

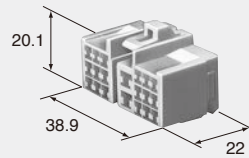

Color Natural

15way (12+3)

Color Natural

Note:Bracket size 17mm

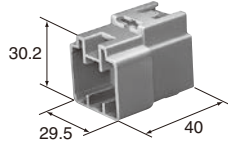

M (6241-0241)

F (6245-0261)

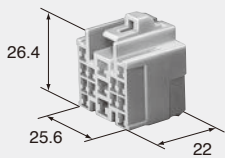

Color Natural

26way (22+4)

M (6249-1254)

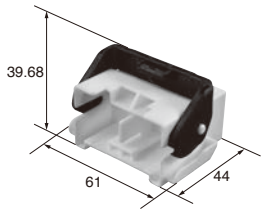

Color Natural

Note:Bracket size 23mm

0.64mm (025)

TS SERIES for PCB

Housing (UNIT : mm)

Material PBT G30/SPS G30

16way

M (6098-6790)

Connector F part No.	6098-4008 (A-05)
Material	PBT G30
Color	Natural

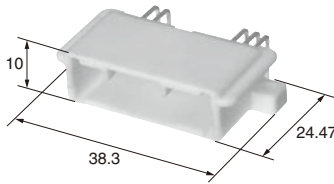

● Detailed dimension
寸法詳細

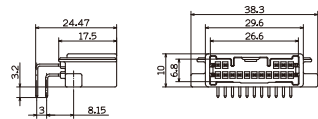

● Recommended dimension of Circuit board
基板推奨詳細

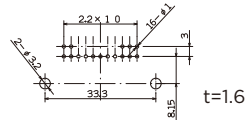

16way

M (6098-6793)

Connector F part No.	6098-4008 (A-05)
Material	SPS G30
Color	Natural

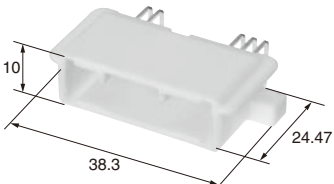

● Detailed dimension
寸法詳細

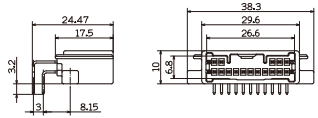

● Recommended dimension of Circuit board
基板推奨詳細

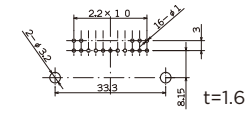

33way

M (6098-7229)

Connector F part No.	6098-7231 (A-05) 6098-7241 (A-04)
Material	SPS G30
Color	Natural

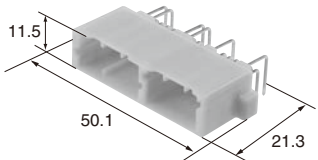

● Detailed dimension
寸法詳細

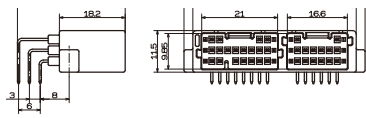

● Recommended dimension of Circuit board
基板推奨詳細

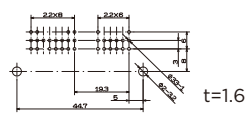

36way

M (6098-6796)

Connector F part No.	6098-4740 (A-06)
Material	PBT G30
Color	Natural

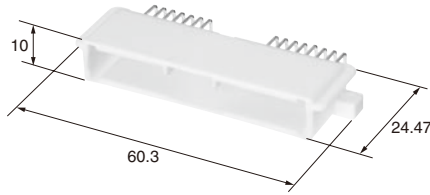

● Detailed dimension
寸法詳細

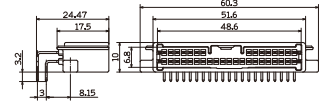

● Recommended dimension of Circuit board
基板推奨詳細

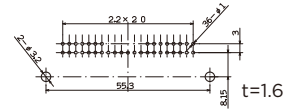

36way

M (6098-6798)

Connector F part No.	6098-4740 (A-06)
Material	SPS G30
Color	Natural

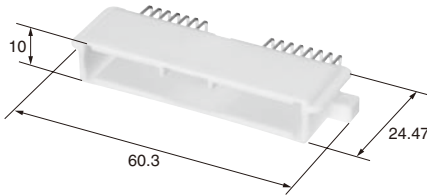

● Detailed dimension
寸法詳細

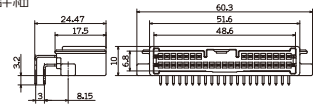

● Recommended dimension of Circuit board
基板推奨詳細

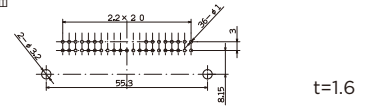

56way (16+16+24)

M (6098-6848)

Connector F part No.	6098-6688 (A-05) 6098-6694 (A-05) 6098-6682 (A-05)
Material	SPS G30
Color	Natural

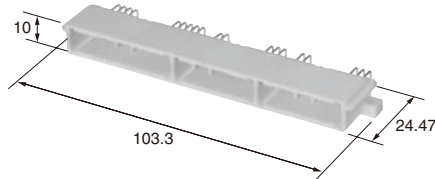

● Detailed dimension
寸法詳細

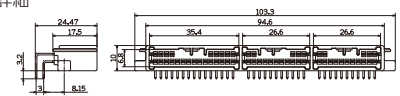

● Recommended dimension of Circuit board
基板推奨詳細

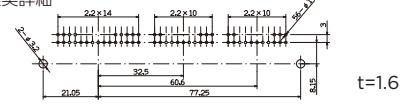

60way (36+24)

M (6098-6803)

Connector F part No.	6098-4010 (A-05) 6098-4740 (A-06)
Material	SPS G30
Color	Natural

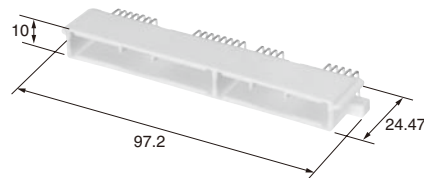

● Detailed dimension
寸法詳細

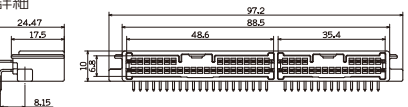

● Recommended dimension of Circuit board
基板推奨詳細

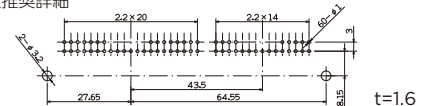

68way (40+28)

M (6098-6805)

Connector F part No.	6098-4756 (A-05) 6098-4831 (A-06)
Material	PBT G30
Color	Natural

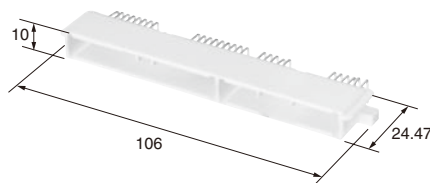

● Detailed dimension
寸法詳細

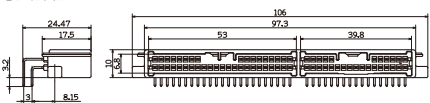

● Recommended dimension of Circuit board
基板推奨詳細

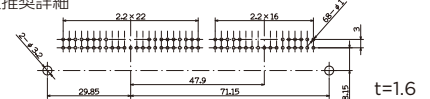

68way (40+28)

M (6098-7102)

Connector F part No.	6098-4756 (A-05) 6098-4831 (A-06)
Material	SPS G30
Color	Natural

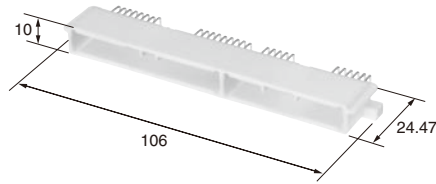

● Detailed dimension
寸法詳細

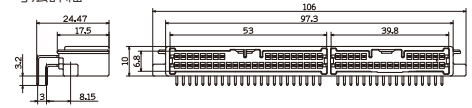

● Recommended dimension of Circuit board
基板推奨詳細

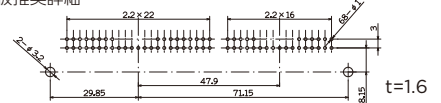

68way (40+28)

M (6098-6810)

Connector F part No.	6098-4756 (A-05) 6098-4015 (A-06)
Material	PBT G30
Color	Blue

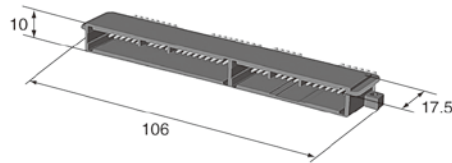

● Detailed dimension
寸法詳細

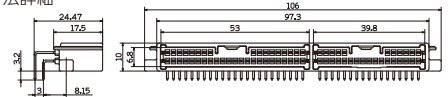

● Recommended dimension of Circuit board
基板推奨詳細

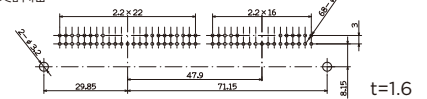

0.64mm, 1.5mm (O25, O60)

Housing (UNIT : mm)

Material LCP

No. of way/ () corresponds to 0.64mm, 1.5mm, in order from left to right.
極数/ () 内表示 : 左から0.64mm 極数、1.5mm 極数

20way (14+6)

M (6098-6869)

Connector F part No.	6098-6876 (A-23)
Material	LCP
Color	Black

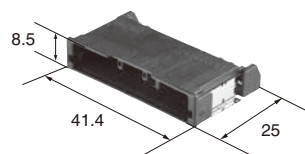

● Detailed dimension
寸法詳細

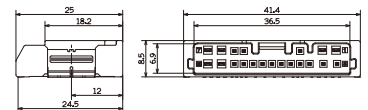

● Recommended dimension of Circuit board
基板推奨詳細

